

STD700 SmartLine Differential Pressure Specification 34-ST-03-101



Introduction

Part of the SmartLine® family of products, the STD700 is suitable for monitoring, control and data acquisition. STD700 products feature piezoresistive sensor technology combining pressure sensing with on chip temperature compensation capabilities providing high accuracy, stability and performance over a wide range of application pressures and temperatures. The SmartLine family is also fully tested and compliant with Experion® PKS providing the highest level of compatibility assurance and integration capabilities. SmartLine easily meets the most demanding application needs for pressure measurement applications.

Best in Class Features:

- Accuracies up to 0.05% of span
- Stability up to 0.02% of URL per year for 5 years
- Automatic static pressure & temperature compensation
- Rangeability up to 100:1
- Response times as fast as 100ms
- Alphanumeric display capabilities
- External zero, span, & configuration capability
- Polarity insensitive electrical connections
- On-board diagnostic capabilities
- Integral Dual Seal design for highest safety based on ANSI/NFPA 70-202 and ANSI/ISA 12.27.0
- World class overpressure protection
- Full compliance to SIL 2/3 requirements.
- Modular design characteristics

Span & Range Limits:

Model	URL “H ₂ O (mbar)	LRL “H ₂ O (mbar)	Max Span “H ₂ O (mbar)	Min Span “H ₂ O (mbar)
STD720	400 (1000)	-400 (1000)	400 (1000)	4 (10)
Model	psi (bar)	psi (bar)	psi (bar)	psi (bar)
STD730	100 (7.0)	-100 (-7.0)	100 (7.0)	1 (0.07)
STD770	3000 (210)	-100 (-7.0)	3000 (210)	30 (2.1)



Figure 1 – STD700 Differential Pressure Transmitters feature field-proven piezoresistive sensor technology

Communications/Output Options:

- Honeywell Digitally Enhanced (DE)
- HART® (version 7.0)
- FOUNDATION™ Fieldbus

All transmitters are available with the above listed communications protocols.

Description

The SmartLine family pressure transmitters are designed around a high performance piezo-resistive sensor. This one sensor actually integrates multiple sensors linking process pressure measurement with on-board static pressure (DP Models) and temperature compensation measurements. This level of performance allows the ST 700 to replace most competitive transmitters available today.

Indication/Display Option

The ST 700 modular design accommodates a basic alphanumeric LCD display.

Basic Alphanumeric LCD Display Features

- Modular (may be added or removed in the field)
- 0, 90, 180, & 270 degree position adjustments
- Configurable (HART only) and standard (Pa, KPa, MPa, KGcm², Torr, ATM, inH₂O, mH₂O, bar, mbar, inH₂O, inHG, FTH₂O, mmH₂O, mm HG, & psi) measurement units
- 2 Lines 16 Characters (4.13H x 1.83W mm)
- Square root output indication (√)

Configuration Tools

Integral Three Button Configuration Option

Suitable for all electrical and environmental requirements, SmartLine offers the ability to configure the transmitter and display via three externally accessible buttons when a display option is selected. Zero/span capabilities are also optionally available via these buttons with or without selection of the display option.

Hand Held Configuration

SmartLine transmitters feature two-way communication and configuration capability between the operator and the transmitter. This is accomplished via Honeywell's field-rated Multiple Communication Configurator (MCT202). The MCT202 is capable of field configuring DE and HART Devices and can also be ordered for use in intrinsically safe environments. All Honeywell transmitters are designed and tested for compliance with the offered communication protocols and are designed to operate with any properly validated hand held configuration device.

Personal Computer Configuration

Honeywell's SCT 3000 Configuration Toolkit provides an easy way to configure Digitally Enhanced (DE) instruments using a personal computer as the configuration interface. Field Device Manager (FDM) Software and FDM Express are also available for managing HART & Fieldbus device configurations.

Diagnostics

SmartLine transmitters all offer digitally accessible diagnostics which aid in providing advanced warning of possible failure events minimizing unplanned shutdowns, providing **lower overall operational costs**

System Integration

- SmartLine communications protocols all meet the most current published standards for HART/DE/Fieldbus.
- Integration with Honeywell's Experion PKS offers the following unique advantages.
 - Tamper reporting
 - FDM Plant Area Views with Health summaries
 - All ST 700 units are Experion tested to provide the highest level of compatibility assurance

Modular Design

To help contain maintenance & inventory costs, all ST 700 transmitters are modular in design supporting the user's ability to replace meter bodies, add indicators or change electronic modules without affecting overall performance or approval body certifications. Each meter body is uniquely characterized to provide in-tolerance performance over a wide range of application variations in temperature and pressure and due to the Honeywell advanced interface, electronic modules may be swapped with any electronics module without losing in-tolerance performance characteristics.

Modular Features

- Meter body replacement
- Exchange/replace electronics/comms modules*
- Add or remove integral indicator*
- Add or remove lightning protection (terminal connection)*

* Field replaceable in all electrical environments (including IS) except flameproof without violating agency approvals.

With no performance effects, Honeywell's unique modularity results in **lower inventory needs and lower overall operating costs**.

Performance Specifications

Reference Accuracy (conformance to +/-3 Sigma)

Table 1

Model	URL	LRL	Min Span	Maximum Turndown Ratio	Stability (% URL/Year for five years)	Reference Accuracy ^{1,2} (% Span)
STD720	400 in H ₂ O/1000 mbar	-400 in H ₂ O/-1000 mbar	4 in H ₂ O/10 mbar	100:1	0.020	0.0500%
STD730	100 psi/7.0 bar	-100 psi/-7.0 bar	1 psi/0.07 bar	100:1	0.040	
STD770	3000 psi/210 bar	-100 psi/-7.0 bar	30 psi/2.1bar	100:1	0.030	

Zero and span may be set anywhere within the listed (URL/LRL) range limits

Accuracy, Temperature and Static Pressure Effects: (Conformance to +/-3)

TABLE II

		Accuracy ^{1,2} (% of Span)				Combined Zero & Span Temperature Effect (% Span/50°F)		Combined Zero & Span Static Line Pressure Effect (% Span/1000psi)	
Model	URL	For Spans Below	A	B	C H ₂ O / mbar	D	E	F	G
STD720	400 in H ₂ O/1000mbar	16:1	0.0125	0.0375	25 / 62.5	0.050	0.020	0.100	0.010
Model	URL	For Spans below	A	B	C psi / bar	D	E	F	G
STD730	100 psi/7.0 bar	4:01	0.0125	0.0375	25 / 1.75	0.065	0.010	0.10	0.01
STD770	3000 psi/210 bar	10:1			300 / 21				
Turn Down Effect $\pm \left[A + B \left(\frac{C}{\text{Span}} \right) \right]$ % Span						Temp Effect $\pm \left[D + E \left(\frac{\text{URL}}{\text{Span}} \right) \right]$ % Span per 28°C (50°F)		Static Effect $\pm \left[F + G \left(\frac{\text{URL}}{\text{Span}} \right) \right]$ % Span per 1000 psi	

Total Performance (% of Span):

$$\text{Total Performance} = \pm \sqrt{(\text{Accuracy})^2 + (\text{Temp Effect})^2 + (\text{Static Line Pressure Effect})^2}$$

Total Performance Examples: (5:1 Turndown, up to 50 °F shift & up to 1000 psi Static Pressure)

STD720 @ 80” H₂O: 0.218% of span

STD730 @ 20 psi: 0.196 % of span

STD770 @ 600 psi: 0.196 % of span

Typical Calibration Frequency:

Calibration verification is recommended every two (2) years

Notes:

- Terminal Based Accuracy – Includes combined effects of linearity, hysteresis and repeatability. Analog output adds 0.005% of span
- For zero based spans and reference conditions of: 25°C (77°F), 0 psig static pressure, 10 to 55% RH and 316SS barrier diaphragm.

Operating Conditions – All Models

Parameter	Reference Condition		Rated Condition		Operative Limits		Transportation and Storage	
	°C	°F	°C	°F	°C	°F	°C	°F
Ambient Temperature ¹	25±1	77±2	-40 to 85	-40 to 185	-40 to 85	-40 to 185	-55 to 120	-67 to 248
Meter Body Temperature ²	25±1	77±2	-40 to 110	-40 to 230	-40 to 125	-40 to 257	-55 to 120	-67 to 248
Humidity %RH	10 to 55		0 to 100		0 to 100		0 to 100	
Vac. Region – Min. Pressure								
mmHg absolute inH₂O absolute	Atmospheric Atmospheric		25 13		2 (short term) ³ 1 (short term) ³			
Supply Voltage Load Resistance	10.8 to 42.4 Vdc at terminals (IS versions limited to 30 Vdc) 0 to 1,440 ohms (as shown in Figure 2)							
Maximum Allowable Working Pressure (MAWP) ^{4,5}	4,500 psi, 310 bar <small>(ST 700 products are rated to Maximum Allowable Working Pressure. MAWP depends on Approval Agency and transmitter materials of construction.)</small>							

¹ LCD Display operating temperature -20°C to +70°C Storage temperature -30°C to 80°C.

² Silicone 704 minimum temperature rating is 0°C (32°F). NEOBEE® M-20 minimum temperature rating is -15°C (5°F).
For STD720 at temperatures below -15°C URL is reduced to 100" H₂O. NEOBEE® is a registered trademark of Stepan Company

³ Short term equals 2 hours at 70°C (158°F)

⁴ MAWP applies for temperatures -40 to 125°C. Static Pressure Limit is de-rated to 3,000 psi for -26°C to -40°C. for all models. Use of graphite o-rings de-rates transmitter to 3,625 psi. Use of 1/2." process adaptors with graphite o-rings de-rates transmitter to 3,000 psi.

⁵ Consult factory for MAWP of ST 700 transmitters with CRN approval.

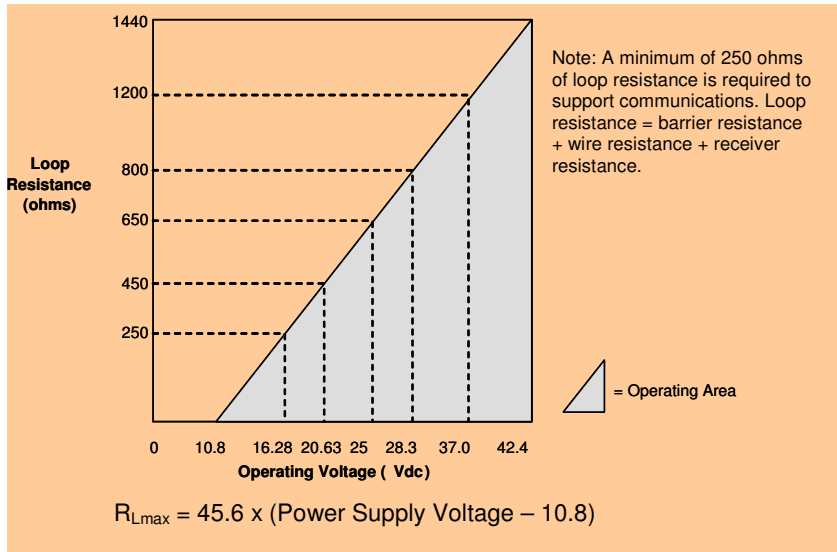

Figure 2 - Supply voltage and loop resistance chart & calculations

Performance Under Rated Conditions – All Models

Parameter	Description									
Analog Output Digital Communications:	Two-wire, 4 to 20 mA (HART & DE Transmitters only) Honeywell DE, HART 7 protocol or FOUNDATION Fieldbus ITK 6.0.1 compliant All transmitters, irrespective of protocol have polarity insensitive connections.									
HART & DE Output Failure Modes (NAMUR for DE Units requires selecting display and configuration buttons or factory configuration)	<table border="0"> <tr> <td></td> <td style="text-align: center;">Honeywell Standard:</td> <td style="text-align: center;">NAMUR NE 43 Compliance:</td> </tr> <tr> <td>Normal Limits:</td> <td style="text-align: center;">3.8 – 20.8 mA</td> <td style="text-align: center;">3.8 – 20.5 mA</td> </tr> <tr> <td>Failure Mode:</td> <td style="text-align: center;">≤ 3.6 mA and ≥ 21.0 mA</td> <td style="text-align: center;">≤ 3.6 mA and ≥ 21.0 mA</td> </tr> </table>		Honeywell Standard:	NAMUR NE 43 Compliance:	Normal Limits:	3.8 – 20.8 mA	3.8 – 20.5 mA	Failure Mode:	≤ 3.6 mA and ≥ 21.0 mA	≤ 3.6 mA and ≥ 21.0 mA
	Honeywell Standard:	NAMUR NE 43 Compliance:								
Normal Limits:	3.8 – 20.8 mA	3.8 – 20.5 mA								
Failure Mode:	≤ 3.6 mA and ≥ 21.0 mA	≤ 3.6 mA and ≥ 21.0 mA								
Supply Voltage Effect	0.005% span per volt.									
Transmitter Turn on Time (includes power up & test algorithms)	HART or DE: 2.5 sec. Foundation Fieldbus: Host dependant									
Response Time (delay + time constant)	<table border="0"> <tr> <td style="text-align: center;"><u>DE/HART Analog Output</u></td> <td style="text-align: center;"><u>FOUNDATION Fieldbus</u></td> </tr> <tr> <td style="text-align: center;">100mS</td> <td style="text-align: center;">150mS (Host Dependant)</td> </tr> </table>	<u>DE/HART Analog Output</u>	<u>FOUNDATION Fieldbus</u>	100mS	150mS (Host Dependant)					
<u>DE/HART Analog Output</u>	<u>FOUNDATION Fieldbus</u>									
100mS	150mS (Host Dependant)									
Damping Time Constant	HART: Adjustable from 0 to 32 seconds in 0.1 increments. Default: 0.50 seconds DE: Discrete values 0, .16, .32, .48, 1, 2, 4, 8, 16, 32 seconds. Default: 0.48 seconds									
Vibration Effect	Less than +/- 0.1% of URL w/o damping Per IEC60770-1 field or pipeline, high vibration level (10-2000Hz: 0.21 displacement/3g max acceleration)									
Electromagnetic Compatibility	IEC 61326-3-1									
Lightning Protection Option	Leakage Current: 10uA max @ 42.4VDC 93C Impulse rating: 8/20uS 5000A (>10 strikes) 10000A (1 strike min.) 10/1000uS 200A (> 300 strikes)									

Materials Specifications (see model selection guide for availability/restrictions with various models)

Parameter	Description
Barrier Diaphragms Material	316L SS, Hastelloy [®] C-276 ² , Monel [®] 400 ³ , Tantalum
Process Head Material	316 SS ⁴ , Carbon Steel (Zinc-plated) ⁵ , Hastelloy C-276 ⁶
Vent/Drain Valves & Plugs¹	316 SS ⁴ , Hastelloy C-276 ²
Head Gaskets	Glass-filled PTFE standard. Viton [®] and graphite are optional.
Meter Body Bolting	Carbon Steel (Zinc plated) standard. Options include 316 SS, NACE A286 SS bolts, Monel K500, Super Duplex and B7M.
Optional Adapter Flange and Bolts	Adapter Flange materials include 316 SS, Hastelloy C-276 and Monel 400. Bolt material for flanges is dependent on process head bolts material chosen. Standard adaptor o-ring material is glass-filled PTFE. Viton and graphite are optional.
Mounting Bracket	2" Pipe, Carbon Steel (Zinc-plated) or 304 Stainless Steel or 316 Stainless Steel
Fill Fluid	Silicone 200 , CTFE, NEOBEE M-20 or Silicone 704
Electronic Housing	Pure Polyester Powder Coated Low Copper (<0.4%)-Aluminum. Meets NEMA 4X, IP66, & IP67. All stainless steel housing is optional.
Mounting	Can be mounted in virtually any position using the standard mounting bracket. Bracket is designed to mount on 2-inch (50 mm) vertical or horizontal pipe. See Figure 3.
Process Connections	1/4- NPT or 1/2- NPT with adapter (meets DIN requirements)
Wiring	Accepts up to 16 AWG (1.5 mm diameter).
Dimensions	See Figure 4.
Net Weight	8.3 pounds (3.8 Kg) with Aluminum Housing.

¹ Vent/Drains are sealed with Teflon[®]² Hastelloy C-276 or UNS N10276³ Monel 400 or UNS N04400⁴ Supplied as 316 SS or as Grade CF8M, the casting equivalent of 316 SS.⁵ Carbon Steel heads are zinc-plated and not recommended for water service due to hydrogen migration. For that service, use 316 stainless steel wetted Process Heads.⁶ Hastelloy C-276 or UNS N10276. Supplied as indicated or as Grade CW12MW, the casting equivalent of Hastelloy C-276

Communications Protocols & Diagnostics

HART Protocol

Version:

HART 7

Power Supply

Voltage: 10.8 to 42.4Vdc at terminals

Load: Maximum 1440 ohms See figure 2

Minimum Load: 0 ohms. (For handheld communications a minimum load of 250 ohms is required)

Foundation Fieldbus (FF)

Power Supply Requirements

Voltage: 9.0 to 32.0Vdc at terminals

Steady State Current: 17.6mAdc

Software Download Current: 27.4mAdc

Available Function Blocks

Block Type	Qty	Execution Time
Resource	1	n/a
Transducer	1	n/a
Diagnostic	1	n/a
Analog Input	1*	30 ms
PID w/Autotune	1	45 ms
Integrator	1	30 ms
Signal Char (SC)	1	30 ms
LCD Display	1	n/a
Flow Block	1	30 ms
Input Selector	1	30 ms
Arithmetic	1	30 ms

* AI block may have two (2) additional instantiations.

All available function blocks adhere to FOUNDATION Fieldbus standards. PID blocks support ideal & robust PID algorithms with full implementation of Auto-tuning.

Link Active Scheduler

Transmitters can perform as a backup Link Active Scheduler and take over when the host is disconnected. Acting as a LAS, the device ensures scheduled data transfers typically used for the regular, cyclic transfer of control loop data between devices on the Fieldbus.

Number of Devices/Segment

Entity IS model: 6 devices/segment

Schedule Entries

18 maximum schedule entries

Number of VCR's: 24 max

Compliance Testing: Tested according to ITK 6.0.1

Software Download

Utilizes Class-3 of the Common Software Download procedure as per FF-883 which allows the field devices of any manufacturer to receive software upgrades from any host.

Honeywell Digitally Enhanced (DE)

DE is a Honeywell proprietary protocol which provides digital communications between Honeywell DE enabled field devices and Hosts.

Power Supply

Voltage: 10.8 to 42.4Vdc at terminals

Load: Maximum 1440 ohms See figure 2

Standard Diagnostics

ST 700 top level diagnostics are reported as either critical or non-critical and readable via the DD/DTM tools or

Critical Diagnostics

HART DD/DTM tools	Basic Display
Electronic Module DAC Failure	Electronics Module fault
Meter Body NVM Corrupt	Meterbody fault
Config Data Corrupt	Electronics Module fault
Electronic Module Diag Failure	Electronics Module fault
Meter Body Critical Failure	Meterbody fault
Sensor Comm Timeout	Meterbody Comm fault

Non-Critical Diagnostics

HART DD/DTM tools
Display Failure
Electronic Module Comm Failure
Meter Body Excess Correct
Sensor Over Temperature
Fixed Current Mode
PV Out of Range
No Factory Calibration
No DAC Compensation
LRV Set Error – Zero Config Button
URV Set Error – Span Config Button
AO Out of Range
Loop Current Noise
Meter Body Unreliable Comm
Tamper Alarm
No DAC Calibration
Sensor Supply Voltage Low

Refer to ST 700 manuals for additional level diagnostic information

Other Certification Options

Materials

- NACE MRO175, MRO103, ISO15156

Approval Certifications:

AGENCY	TYPE OF PROTECTION	COMM. OPTION	FIELD PARAMETERS	AMBIENT TEMP (Ta)
FM Approvals™	Explosionproof: Class I, Division 1, Groups A, B, C, D; Dust Ignition Proof: Class II, III, Division 1, Groups E, F, G; T4 Class I, Zone 0/1, AEx d IIC Ga/Gb T4 Class II, Zone 21, AEx tb IIIC Db T 95°C	All	Note 1	-50 °C to 85°C
	Intrinsically Safe: Class I, II, III, Division 1, Groups A, B, C, D, E, F, G; T4 Class I, Zone 0, AEx ia IIC Ga T4 FISCO Field Device (Only for FF Option) Ex ia IIC T4	4-20 mA / DE/ HART	Note 2a	-50 °C to 70°C
	FISCO Field Device (Only for FF Option) Ex ia IIC T4	Foundation Fieldbus	Note 2b	-50 °C to 70°C
	Nonincendive: Class I, Division 2, Groups A, B, C, D locations, Class I, Zone 2, AEx nA IIC Gc T4	4-20 mA / DE/ HART/ Foundation Fieldbus	Note 1	-50 °C to 85°C
	Enclosure: Type 4X/ IP66/ IP67	All	All	-
	Explosion Proof: Class I, Division 1, Groups A, B, C, D; Dust Ignition Proof: Class II, III, Division 1, Groups E, F, G; T4 Ex d IIC Ga T4 Ex tb IIIC Db T 95°C	All	Note 1	-50 °C to 85°C
Canadian Standards Association (CSA)	Intrinsically Safe: Class I, II, III, Division 1, Groups A, B, C, D, E, F, G; T4 Ex ia IIC Ga T4 FISCO Field Device (Only for FF Option) Ex ia IIC T4	4-20 mA / DE/ HART	Note 2a	-50 °C to 70°C
	FISCO Field Device (Only for FF Option) Ex ia IIC T4	Foundation Fieldbus	Note 2b	-50 °C to 70°C
	Nonincendive: Class I, Division 2, Groups A, B, C, D; T4 Ex nA IIC Gc T4	4-20 mA / DE/ HART/ Foundation Fieldbus	Note 1	-50 °C to 85°C
	Enclosure: Type 4X/ IP66/ IP67	All	All	-

Approval Certifications: (Continued)

ATEX	Flameproof: II 1/2 G Ex d IIC Ga/Gb T4 II 2 D Ex tb IIIC Db T 95°C	All	Note 1	-50 °C to 85°C
	Intrinsically Safe: II 1 G Ex ia IIC Ga T4	4-20 mA / DE/ HART	Note 2a	-50 °C to 70°C
	FISCO Field Device (Only for FF Option) Ex ia IIC T4	Foundation Fieldbus	Note 2b	-50 °C to 70°C
	Nonincendive: II 3 G Ex nA IIC Gc T4	4-20 mA / DE/ HART/ Foundation Fieldbus	Note 1	-50 °C to 85°C
	Enclosure: IP66/ IP67	All	All	-
IECEX (World)	Flameproof : Ex d IIC Ga/Gb T4 Ex tb IIIC Db T 95°C	All	Note 1	-50 °C to 85°C
	Intrinsically Safe: Ex ia IIC Ga T4	4-20 mA / DE/ HART	Note 2a	-50 °C to 70°C
	FISCO Field Device (Only for FF Option) Ex ia IIC T4	Foundation Fieldbus	Note 2b	-50 °C to 70°C
	Nonincendive: Ex nA IIC Gc T4	4-20 mA / DE/ HART/ Foundation Fieldbus	Note 1	-50 °C to 85°C
	Enclosure: IP66/ IP67	All	All	-
SAEx (South Africa)	Flameproof : Ex d IIC Ga/Gb T4 Ex tb IIIC Db T 95°C	All	Note 1	-50 °C to 85°C
	Intrinsically Safe: Ex ia IIC Ga T4	4-20 mA / DE/ HART	Note 2a	-50 °C to 70°C
	FISCO Field Device (Only for FF Option) Ex ia IIC T4	Foundation Fieldbus	Note 2b	-50 °C to 70°C
	Nonincendive: Ex nA IIC Gc T4	4-20 mA / DE/ HART/ Foundation Fieldbus	Note 1	-50 °C to 85°C
	Enclosure: IP66/ IP67	All	All	-
INMETRO (Brazil)	Flameproof: Ex d IIC Ga/ Gb T4 Ex tb IIIC Db T 95°C	All	Note 1	T5 Ta = -50 to 93°C
	Intrinsically Safe: Ex ia IIC Ga T4	4-20 mA / DE/ HART	Note 2a	T4 Ta = -50 to 93°C
	FISCO Field Device (Only for FF Option) Ex ia IIC T4	Foundation Fieldbus	Note 2b	T4 Ta = -50 to 70°C
	Nonincendive: Ex nA IIC Gc T4	4-20 mA / DE/ HART/ Foundation Fieldbus	Note 1	-50 °C to 85°C
	Enclosure : IP 66/67	All	All	-

Approval Certifications: (Continued)

NEPSI (China)	Flameproof: Ex d IIC Ga/Gb T4 Ex tb IIIC Db T 85°C	All	Note 1	T5 Ta = -50 to 93°C
	Intrinsically Safe: Ex ia IIC Ga T4	4-20 mA / DE/ HART	Note 2a	-50 °C to 70°C
	FISCO Field Device (Only for FF Option) Ex ia IIC T4	Foundation Fieldbus	Note 2b	-50 °C to 70°C
	Nonincendive: Ex nA IIC Gc T4	4-20 mA / DE/ HART/ Foundation Fieldbus	Note 1	-50 °C to 85°C
	Enclosure : IP 66/67	All	All	-
GOST	Flameproof: 1 Ex d IIC Ga/Gb T4 Ex tb IIIC Db T 85°C	All	Note 1	-50 °C to 85°C
	Intrinsically Safe: 0 Ex ia IIC Ga T4	4-20 mA / DE/ HART	Note 2a	-50 °C to 70°C
	FISCO Field Device (Only for FF Option) Ex ia IIC T4	Foundation Fieldbus	Note 2b	-50 °C to 70°C
	Enclosure : IP 66/67	All	All	

Notes:

1. Operating Parameters:

Voltage= 11 to 42 V DC Current= 4-20 mA Normal
 = 10 to 30 V (FF) = 30 mA (FF)

2. Intrinsically Safe Entity Parameters

a. Analog/ DE/ HART Entity Values:

V_{max}= U_i = 30V I_{max}= I_i= 105mA C_i = 4.2nF L_i =984 uH P_i =0.9W

Transmitter with Terminal Block Revision E or Later)

V_{max}= U_i = 30V I_{max}= I_i= 225mA C_i = 4.2nF L_i = 0 P_i =0.9W

Note : Transmitter with Terminal Block Revision E or later

The revision is on the label that is on the module. There will be two lines of text on the label:

- First is the Module Part #: 50049839-001 or 50049839-002
- Second line has the supplier information, along with the REVISION:
 XXXXXX-EXXX, THE "X" is production related, THE POSITION of the "E" IS THE REVISION.

b. Foundation Fieldbus- Entity Values

V_{max}= U_i = 30V I_{max}= I_i= 180mA C_i = 0nF L_i = 984 uH P_i =1W

Transmitter with Terminal Block Revision F or Later)

V_{max}= U_i = 30V I_{max}= I_i= 225mA C_i = 0nF L_i = 0 P_i =1 W

FISCO Field Device I_{max}= I_i= 380 mA C_i = 0nF L_i = 0 P_i =5.32 W

V_{max}= U_i = 17.5V

Note : Transmitter with Terminal Block Revision F or later

The revision is on the label that is on the module. There will be two lines of text on the label:

- First is the Module Part #: 50049839-003 or 50049839-004
- Second line has the supplier information, along with the REVISION:
 XXXXXX-EXXX, THE "X" is production related, THE POSITION of the "E" IS THE REVISION.

Approval Certifications: (Continued)

Marine Certificates	<p>This certificate defines the certifications covered for the ST 800 Pressure Transmitter family of products, including the SMV 800 Smart Multivariable Transmitter. It represents the compilation of the five certificates Honeywell currently has covering the certification of these products into marine applications.</p> <p>For ST 800 Smart Pressure Transmitter and SMV800 Smart Multivariable Transmitter</p>
	<p>American Bureau of Shipping (ABS) - 2009 Steel Vessel Rules 1-1-4/3.7, 4-6-2/5.15, 4-8-3/13 & 13.5, 4-8-4/27.5.1, 4-9-7/13. Certificate number: 04-HS417416-PDA</p>
	<p>Bureau Veritas (BV) - Product Code: 389:1H. Certificate number: 12660/B0 BV</p>
	<p>Det Norske Veritas (DNV) - Location Classes: Temperature D, Humidity B, Vibration A, EMC B, Enclosure C. For salt spray exposure; enclosure of 316 SST or 2-part epoxy protection with 316 SST bolts to be applied. Certificate number: A-11476</p>
	<p>Korean Register of Shipping (KR) - Certificate number: LOX17743-AE001</p>
	<p>Lloyd's Register (LR) - Certificate number: 02/60001(E1) & (E2)</p>
SIL 2/3 Certification	<p>IEC 61508 SIL 2 for non-redundant use and SIL 3 for redundant use according to EXIDA and TÜV Nord Sys Tec GmbH & Co. KG under the following standards: IEC61508-1: 2010; IEC 61508-2: 2010; IEC61508-3: 2010.</p>

Mounting & Dimensional Drawings

Reference Dimensions: $\frac{\text{millimeters}}{\text{inches}}$

Mounting Configurations

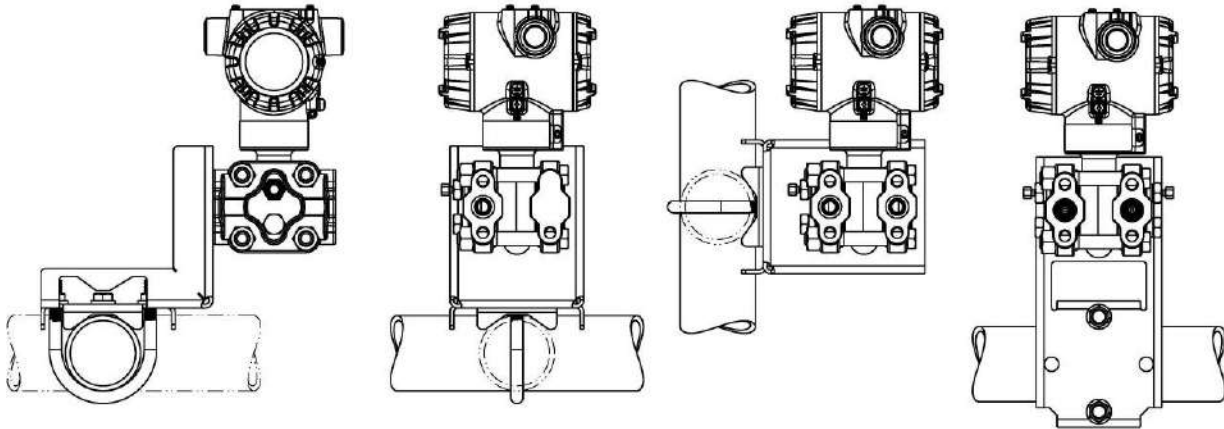

Dimensions

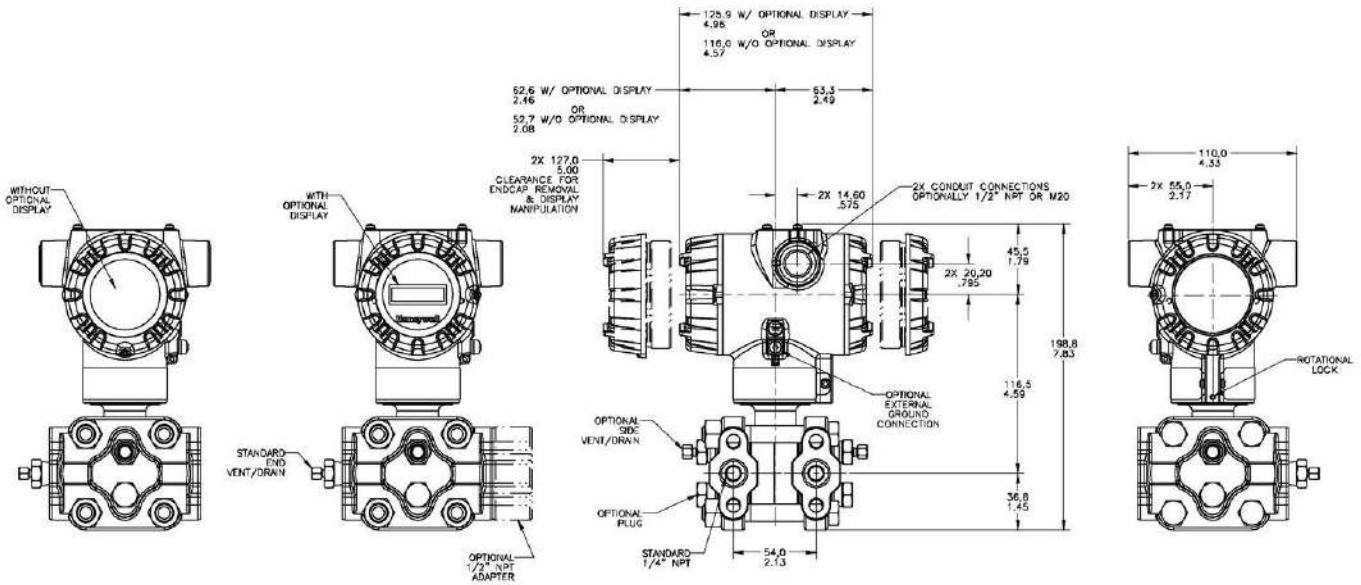

Figure 4 – Typical mounting dimensions of STD720, STD730 & STD770 for reference only

Model Selection Guides are subject to change and are inserted into the specifications as guidance only. Prior to specifying or ordering a model check for the latest revision Model Selection Guides which are published at: www.honeywellprocess.com/en-US/pages/default.aspx

Model Selection Guide

**Model STD700
Differential Pressure Transmitter**

Model Selection Guide:
34-ST-16-101 Issue 9



Instructions: Make selections from small Tables: Key through XIII using column below the proper arrow. Asterisk indicates availability. Letter (a) refer to restrictions highlighted in the restrictions table. Tables delimited with dashes.

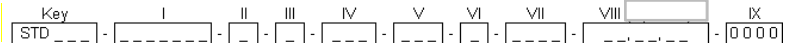

KEY NUMBER	URL	LRL	Max Span	Min Span	Units
a. Measurement Range	400/(1000)	-400/(-1000)	400/(1000)	4.0 (10)	" H ₂ O (mbar)
	100 (7.0)	-100 (-7.0)	100 (7.0)	1 (0.07)	psi (bar)
	3000 (210)	-100 (-7.0)	3000 (210)	30 (2.1)	psi (bar)

Selection

STD720	↓		
STD730		↓	
STD770			↓

TABLE I		METER BODY SELECTIONS			
a. Process Wetted Heads & Diaphragm Materials	Process Head Material		Diaphragm Material		
	Plated Carbon Steel	316L Stainless Steel			
		Hastelloy® C-276 Monel® 400 Tantalum			
	316 Stainless Steel	316L Stainless Steel			
Hastelloy C-276 Monel 400 Tantalum					
Hastelloy C-276 Monel 400	Hastelloy C-276				
	Tantalum Monel® 400				
b. Fill Fluid	Silicone Oil 200				
	Fluorinated Oil CTFE				
	Silicone Oil 704				
	NEOBEE® M-20				
c. Process Connection	None	None (1/4" NPTF female thread Std)			
	1/2" NPT female	Materials to Match Head & Head Bolt Materials Selections ¹			
d. Bolt/Nut Materials	Carbon Steel				
	316 SS				
	Grade 660 (NACE A286) with NACE 304 SS Nuts				
	Grade 660 (NACE A286) Bolts & Nuts				
	Monel K500				
	Super Duplex B7M				
e. Vent/Drain Type/Location	Head Type	Vent Type	Location	Vent Material	
	Single Ended	None	None	None	
	Single Ended	Standard Vent	Side	Matches Head Material ¹	
	Single Ended	Center Vent	Side	Stainless Steel Only	
	Dual Ended	Standard Vent	End	Matches Head Material ¹	
	Dual Ended	Center Vent	End	Stainless Steel Only	
Dual Ended	Std Vent/Plug	Side/End	Matches Head Material ¹		
f. Gasket Material	Teflon® or PTFE (Glass Filled)				
	Viton® or Fluorocarbon Elastomer				
	Graphite				
g. Static Pressure	Standard Static Pressure - 4500 psig (315 bar)				

A	*	*	*
B	*	*	*
C	a	a	a
D	a	a	a
E	*	*	*
F	*	*	*
G	a	a	a
H	a	a	a
J	*	*	*
K	a	a	a
L	a	a	a

_1	*	*	*
_2	*	*	*
_3	*	*	*
_4	*	*	*
_A	*	*	*
_H	*	*	*

_C	*	*	*
_S	*	*	*
_N	*	*	*
_K	p	p	p
_M	p	p	p
_D	p	p	p
_B	*	*	*

_1	*	*	*
_2	*	*	*
_3	t	t	t
_4	*	*	*
_5	t	t	t
_6	*	*	*

_A	*	*	*
_B	*	*	*
_C	*	*	*
_S	*	*	*

¹Except Carbon Steel Heads shall use 316SS Vent/Drain, Plugs & Adapters when required

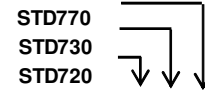
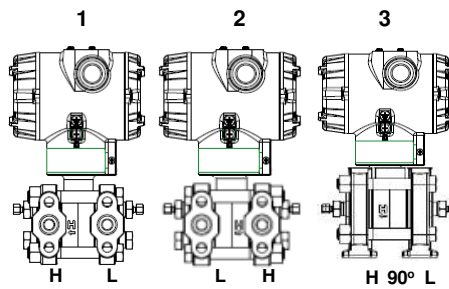

TABLE II		Meter Body & Connection Orientation
Head/Connect Orientation	Standard	High Side Left, Low Side Right ² / Std Head Orientation
	Reversed	Low Side Left, High Side Right ² / Std Head Orientation
	90/Standard	High Side Left, Low Side Right ² / 90 ^U Head Rotation

1	*	*	*
2	*	*	*
3	h	h	h

TABLE III		Agency Approvals (see data sheet for Approval Code Details)
Approvals	No Approvals Required	
	FM Explosion proof, Intrinsically Safe, Non-incendive, & Dustproof	
	CSA Explosion proof, Intrinsically Safe, Non-incendive, & Dustproof	
	ATEX Explosion proof, Intrinsically Safe & Non-incendive	
	IECEX Explosion proof, Intrinsically Safe & Non-incendive	
	SAEx/CCoE Explosion proof, Intrinsically Safe & Non-incendive	
	INMETRO Explosion proof, Intrinsically Safe & Non-incendive	
	NEPSI Explosion proof, Intrinsically Safe & Non-incendive	

0	*	*	*
A	*	*	*
B	*	*	*
C	*	*	*
D	*	*	*
E	*	*	*
F	*	*	*
G	*	*	*

TABLE IV		TRANSMITTER ELECTRONICS SELECTIONS		
a. Electronic Housing Material & Connection Type	Material	Connection	Lightning Protection	
	Polyester Powder Coated Aluminum	1/2 NPT	None	
	Polyester Powder Coated Aluminum	M20	None	
	Polyester Powder Coated Aluminum	1/2 NPT	Yes	
	Polyester Powder Coated Aluminum	M20	Yes	
	316 Stainless Steel (Grade CF8M)	1/2 NPT	None	
	316 Stainless Steel (Grade CF8M)	M20	None	
	316 Stainless Steel (Grade CF8M)	1/2 NPT	Yes	
316 Stainless Steel (Grade CF8M)	M20	Yes		
b. Output/ Protocol	Analog Output		Digital Protocol	
	4-20mA dc		HART Protocol	
	4-20mA dc n/a		DE Protocol Foundation Fieldbus	
c. Customer Interface Selections	Indicator	Ext Zero, Span & Config Buttons	Languages	
	None	None	None	
	None	Yes (Zero/Span Only)	None	
	Basic	None	English	
	Basic	Yes	English	

A__	*	*	*
B__	*	*	*
C__	*	*	*
D__	*	*	*
E__	*	*	*
F__	*	*	*
G__	*	*	*
H__	*	*	*

H	*	*	*
D	*	*	*
F	*	*	*

__0	*	*	*
__A	f	f	f
__B	*	*	*
__C	*	*	*

TABLE V		CONFIGURATION SELECTIONS		
a. Application Software	Diagnostics			
	Standard Diagnostics			
b. Output Limit, Failsafe & Write Protect Settings	Write Protect	Fail Mode	High & Low Output Limits ³	
	Disabled	High> 21.0mAdc	Honeywell Std (3.8 - 20.8 mAdc)	
	Disabled	Low< 3.6mAdc	Honeywell Std (3.8 - 20.8 mAdc)	
	Enabled	High> 21.0mAdc	Honeywell Std (3.8 - 20.8 mAdc)	
	Enabled	Low< 3.6mAdc	Honeywell Std (3.8 - 20.8 mAdc)	
	Enabled	N/A	N/A	Fieldbus
c. General Configuration	Factory Standard			
	Custom Configuration (Unit Data Required from customer)			

1__	*	*	*
-----	---	---	---

1	f	f	f
2	f	f	f
3	f	f	f
4	f	f	f
5	g	g	g
6	g	g	g

__S	*	*	*
__C	*	*	*

² Left side/Right side as view ed from the customer connection perspective

³ NAMUR Output Limits 3.8 - 20.5mAdc can be configured by the customer or select custom configuration Table Vc

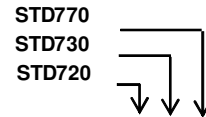

TABLE VI CALIBRATION & ACCURACY SELECTIONS			
a. Accuracy and Calibration	Accuracy	Calibrated Range	Calibration Qty
	Standard	Factory Std	Single Calibration
	Standard	Custom (Unit Data Required)	Single Calibration

A	*	*	*
B	*	*	*

TABLE VII ACCESSORY SELECTIONS		
a. Mounting Bracket	Bracket Type	Material
	None	None
	Angle Bracket	Carbon Steel
	Angle Bracket	304 SS
	Angle Bracket	316 SS
	Marine Approved Bracket	Carbon Steel
	Marine Approved Bracket	304 SS
	Flat Bracket	Carbon Steel
	Flat Bracket	304 SS
Flat Bracket	316 SS	
b. Customer Tag	Customer Tag Type	
	No customer tag	
	One Wired Stainless Steel Tag (Up to 4 lines 26 char/line)	
	Two Wired Stainless Steel Tag (Up to 4 lines 26 char/line)	
c. Unassembled Conduit Plugs & Adapters	Unassembled Conduit Plugs & Adapters	
	No Conduit Plugs or Adapters Required	
	1/2 NPT Male to 3/4 NPT Female 316 SS Certified Conduit Adapter	
	1/2 NPT 316 SS Certified Conduit Plug	
	M20 316 SS Certified Conduit Plug	
	Minifast® 4 pin (1/2 NPT) (not suitable for X-Proof applications)	
	Minifast® 4 pin (M20) (not suitable for X-Proof applications)	

0	---	*	*	*
1	---	*	*	*
2	---	*	*	*
3	---	*	*	*
8	---	*	*	*
4	---	*	*	*
5	---	*	*	*
6	---	*	*	*
7	---	*	*	*

_	0	_	*	*	*
_	1	_	*	*	*
_	2	_	*	*	*

_	A0	*	*	*
_	A2	n	n	n
_	A6	n	n	n
_	A7	m	m	m
_	A8	n	n	n
_	A9	m	m	m

TABLE VIII OTHER Certifications & Options: (String in sequence comma delimited (XX, XX, XX,...))	
Certifications & Warranty	None - No additional options
	NACE MR0175; MR0103; ISO15156 (FC33338) Process wetted parts only
	NACE MR0175; MR0103; ISO15156 (FC33339) Process wetted and non-wetted parts
	Marine (DNV, ABS, BV, KR, LR)
	EN10204 Type 3.1 Material Traceability (FC33341)
	Certificate of Conformance (F3391)
	Calibration Test Report & Certificate of Conformance (F3399)
	Certificate of Origin (F0195)
	FMEDA (SIL 2/3) Certification (FC33337)
	Over-Pressure Leak Test Certificate (1.5X MAWP) (F3392)
	Cert Clean for O ₂ or CL ₂ service per ASTM G93

00	*	*	*	
FG	*	*	*	b
F7	c	c	c	
MT	d	d	d	
FX	*	*	*	
F3	*	*	*	b
F1	*	*	*	
F5	*	*	*	
FE	j	j	j	
TP	*	*	*	
OX	e	e	e	

TABLE IX Manufacturing Specials	
Factory	Factory Identification
	0000 * * *

MODEL RESTRICTIONS

Restriction Letter	Available Only with		Not Available with	
	Table	Selection(s)	Table	Selection(s)
a			VIII	F7, FG
c	1d	___ N,K,D,B ___	Ia	C,D,G,H,K,L
d			VIIa	1,2,3,5,6,7
e	1b	_ 2 _____		
f			IVb	_ F _
g			IVb	_ H, D _
h			Ie	4, 5, 6
			VIIa	1,2,3,4,5,6,7
j	IVb	_ H _	Vb	_ 1,2,6 _
m	IVa	B, D, F, H __		
n	IVa	A, C, E, G __		
p			III	B- No CRN number available
t			Ia	J, K, L
b	Select only one option from this group			

Sales and Service

For application assistance, current specifications, pricing, or name of the nearest Authorized Distributor, contact one of the offices below.

ASIA PACIFIC

Honeywell Process Solutions,
(TAC) hfs-tac-support@honeywell.com

Australia

Honeywell Limited
Phone: +(61) 7-3846 1255
FAX: +(61) 7-3840 6481
Toll Free 1300-36-39-36
Toll Free Fax:
1300-36-04-70

China – PRC - Shanghai

Honeywell China Inc.
Phone: (86-21) 5257-4568
Fax: (86-21) 6237-2826

Singapore

Honeywell Pte Ltd.
Phone: +(65) 6580 3278
Fax: +(65) 6445-3033

South Korea

Honeywell Korea Co Ltd
Phone: +(822) 799 6114
Fax: +(822) 792 9015

EMEA

Honeywell Process Solutions,
Phone: + 80012026455 or
+44 (0)1344 656000

Email: (Sales)

FP-Sales-Apps@Honeywell.com

or

(TAC)

hfs-tac-support@honeywell.com

AMERICA'S

Honeywell Process Solutions,
Phone: (TAC) 1-800-423-9883 or
215/641-3610
(Sales) 1-800-343-0228

Email: (Sales)

FP-Sales-Apps@Honeywell.com

or

(TAC)

hfs-tac-support@honeywell.com

Specifications are subject to change without notice.

For more information

To learn more about SmartLine Pressure Transmitters visit www.honeywellprocess.com
Or contact your Honeywell Account Manager

Process Solutions

Honeywell
1250 W Sam Houston Pkwy S
Houston, TX 77042

Honeywell Control Systems Ltd
Honeywell House, Skimped Hill Lane
Bracknell, England, RG12 1EB

Shanghai City Centre, 100 Jungi Road
Shanghai, China 20061

www.honeywellprocess.com

34-ST-03-101
December 2014

©2014 Honeywell International Inc.

Honeywell