

## Aktor T ST

### Thermal Actuator (0 – 10 V)



Thermal actuators are used in the heating, ventilation and air conditioning trades. The actuators can be used for room temperature control or as zone valves. In combination with Oventrop thermostatic valves or heating circuit manifolds and Oventrop room thermostats, they enable individual room temperature control.

The Aktor T ST for modulating control is a proportional actuator with a control voltage of 0 – 10 V. If a control voltage of 0.5 – 9.5 V is applied, the actuator opens the valve – after the dead time has elapsed – by means of the stem movement in proportion to the control voltage. In the range from 0 V to 0.5 V, the actuator remains in the idle state to ignore ripple voltages caused by long cable lengths. If a control voltage between 9.5 V and 10 V is applied, the actuator moves to the maximum stroke of 5 mm or to the maximum valve stroke determined by the valve stroke detection. The actuator is “normally closed”, so that the valve is opened evenly when voltage is applied; this can be seen from the extended stroke indicator. If no voltage is applied to the actuator, the valve closes evenly after the idle time has elapsed.

The room temperature can be controlled with the ClimaCon F 310 24 V room thermostat or other Oventrop room thermostats in 24 V version with 0 – 10 V output. In addition, a time-controlled setback is possible via the room thermostats.

The Oventrop actuators work with an expansion element so that low-noise operation with low power consumption is possible.

### Features

- + Simple plug-in mounting on valve adapter
- + Universal application
- + Mounting independent of position
- + Low-noise operation with low power consumption

# Product Details

## Thermal actuator (0 – 10 V)

### Functions

- Modulating control
- First-open function
- Ignoring ripple voltages
- Stroke indicator
- Zero point detection
- Automatic control stroke detection

In the delivery state, the actuator is "normally open" due to the first-open function. This enables heating operation during the shell construction phase, even if the electrical wiring has not yet been completed. For later commissioning, the actuator should already be mounted on the valve. When the operating voltage is applied for the first time (longer than 10 minutes), the first-open function is automatically released. This only happens once, so that control mode starts immediately in the event of voltage interruptions.

Maximum cable length for an actuator with specified cable cross-sections (voltage drop approx. 1.2 V at 24 V). When using several actuators, the specified cable length must be divided by the number of actuators.

Cable cross section (mm <sup>2</sup> )	Max. length (m)
2 x 0.22	20
2 x 0.80	45
2 x 1.50	136

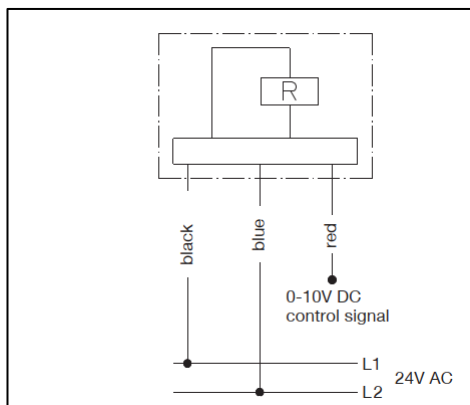

Wiring diagram

### Technical Data

Item no.	1012953
Connection thread	M 30 x 1.5
Operating voltage	24 V AC, - 10 %...+20%. 50 / 60 Hz
Switch-on current	< 320 mA für max. 2 Min.
Continuous current	approx. 42 mA
Control voltage	0 – 10 V DC
Input impedance	100 kΩ
Travel	5.0 mm
Control stroke	Automatic detection
Positioning force	> 90 N
Average positioning time	30 s/mm
Protection type	IP 54 in all installation positions
Protection class	III according to EN 60730
Medium temperature	0...+100 °C
Ambient temperature	0...+60 °C
Storage temperature	-25...+60 °C
Connection cable	3 x 0.22 mm <sup>2</sup> , length 1 m, pluggable

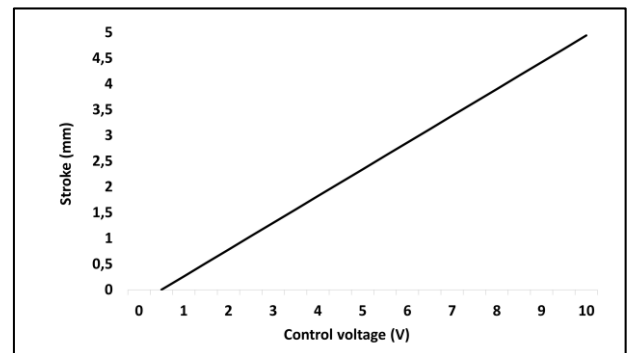

Stroke-control voltage-characteristic line (max. stroke without valve)

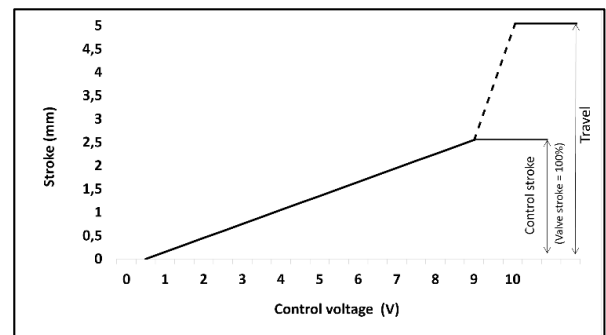

Stroke-control voltage-characteristic line with detected valve travel

## Range of application, installation and mounting

The electrical connection must comply with the regulations of the local Electricity Board.

The connection cable must not be laid on heat-carrying pipes or the like, as this accelerates the ageing of the cable material. When selecting the switching contacts and the mains fuse, the switch-on current of the heating element must be taken into account.

The actuators are mounted by means of a valve adapter and do not require any tools. The valve adapter is screwed onto the valve by hand and is attached to the adapter by plug-in mounting.

The Oventrop thermal actuators can be operated in all installation positions. Vertical (stroke indicator at the top) and horizontal positions are preferable. When mounted vertically downwards, special circumstances (e.g. dirty water) can reduce the service life.

A safety transformer according to EN 61558-2-6 must always be used. The dimensioning of the transformer results from the switch-on power of the actuators.

## Rule of thumb

$$P_{\text{Transformer}} = 6 \text{ W} \times n$$

$n = \text{Number of actuators}$

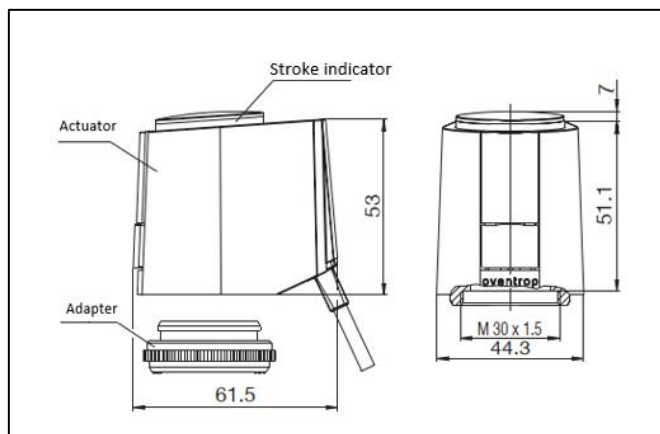

Dimensions

## Accessories

### Reinforcing cap

To protect the thermal actuators against vandalism.

	Suitable for valves with	Item no.
	Connection thread M 30 x 1.5	1012450

### Room thermostats

For time-controlled room temperature control.

	Version	Item no.
	24 V, heating or cooling	1155531
	24 V, heating and cooling	1152151
	24 V, Heating or cooling	1152064
	24 V, Heating and cooling	1152065

### Valve adapter

For thermal actuators.

	Suitable for valves with	Item no.
	Connection thread M 30 x 1.5	1012461 (replacement)
	Connection thread M 30 x 1.5 high model (11 mm)	1012462
	Connection thread M 30 x 1.0	1012890 (manufactured until 1998)
	Squeeze connection	1012463

Subject to changes • All rights reserved • © 2023 Oventrop GmbH & Co. KG  
EN-12201-1012953-DB-V2314 – April 2023

Oventrop GmbH & Co. KG • Paul-Oventrop-Straße 1 • 59939 Olsberg • Germany  
T +49 2962 820 • mail@oventrop.de • www.oventrop.de