

STD700 SmartLine Differential Pressure Specification 34-ST-03-101, April 2023



Introduction

Part of the SmartLine® family of products, the STD700 is suitable for monitoring, control and data acquisition featuring piezoresistive sensor technology. By combining pressure sensing with on chip temperature compensation capabilities STD700 offers high accuracy, stability and performance over a wide range of application pressures and temperatures. The SmartLine family is also fully tested and compliant with Experion® PKS providing the highest level of compatibility assurance and integration capabilities. SmartLine easily meets the most demanding application needs for pressure measurement applications.

Best in Class Features:

- Accuracies up to 0.05% of span standard & 0.04% of span optional
- Stability up to 0.02% of URL per year for 10 years
- Automatic static pressure & temperature compensation
- Rangeability up to 100:1
- Response times as fast as 100ms
- Alphanumeric display capabilities
- External zero, span, & configuration capability
- Polarity insensitive electrical connections
- Comprehensive on-board diagnostic capabilities
- Integral Dual Seal design for highest safety based on ANSI/NFPA 70-202 and ANSI/ISA 12.27.0
- World class overpressure protection
- Full compliance to SIL 2/3 requirements.
- Modular design characteristics
- Available with additional 4-year warranty



Figure 1 – STD700 Differential Pressure Transmitters feature field-proven piezoresistive sensor technology

Communications/Output Options:

- Honeywell Digitally Enhanced (DE)
- HART® (version 7.0)
- FOUNDATION™ Fieldbus

All transmitters are available with the above listed communications protocols.

Span & Range Limits:

Model	URL inH ₂ O (mbar)	LRL inH ₂ O (mbar)	Min Span inH ₂ O (mbar)
STD720	400 (1000)	-400 (1000)	4 (10)
Model	psi (bar)	psi (bar)	psi (bar)
STD730	100 (7.0)	-100 (-7.0)	1 (0.07)
STD770	3000 (210)	-100 (-7.0)	30 (2.1)

Description

The SmartLine family pressure transmitters are designed around a high performance piezo-resistive sensor. This one sensor actually integrates multiple sensors linking process pressure measurement with on-board static pressure (DP Models) and temperature compensation measurements. This level of performance allows the ST 700 to replace most competitive transmitters available today.

Indication/Display Option

The ST 700 modular design accommodates a basic alphanumeric LCD display.

Basic Alphanumeric LCD Display Features

- Modular (may be added or removed in the field)
- 0, 90, 180, & 270 degree position adjustments
- Configurable (HART only) and standard (Pa, KPa, MPa, KGcm², Torr, ATM, inH₂O, mH₂O, bar, mbar, inH₂O, inHG, FTH₂O, mmH₂O, mm HG, & psi) measurement units
- Supports Flow engineering units
- 2 Lines 16 Characters (4.13H x 1.83W mm)
- Square root output indication (√)

Simple LCD Display Features

- Modular (may be added or removed in the field)
- Supports HART protocol variant
- 0, 90, 180, & 270 degree position adjustments
- Configurable (HART only) and standard (Pa, KPa, MPa, KGcm², Torr, ATM, inH₂O, mH₂O, bar, mbar, inH₂O, inHG, FTH₂O, mmH₂O, mm HG, & psi) measurement units.
- Supports Flow engineering units
- 2 Lines 6 digits PV (9.95H x 4.20W mm) 8 Characters
- Square root output indication (√) and Write protect Indication
- Built in Basic Device Configuration through Internal Buttons – Range/Engineering Unit/Loop Test /Loop Calibration/Zero /Span Setting

Diagnostics

SmartLine transmitters all offer digitally accessible diagnostics which aid in providing advanced warning of possible failure events minimizing unplanned shutdowns, providing **lower overall operational costs**

System Integration

- SmartLine communications protocols all meet the most current published standards for HART/DE/Fieldbus.
- Integration with Honeywell's Experion PKS offers the following unique advantages.
 - Tamper reporting
 - FDM Plant Area Views with Health summaries
 - All ST 700 units are Experion tested to provide the highest level of compatibility assurance

Configuration Tools

External Three Button Configuration Option

Suitable for all electrical and environmental requirements, SmartLine offers the ability to configure the transmitter and display via three externally accessible buttons when a display option is selected. Zero/span capabilities are also optionally available via these buttons with or without selection of the display option.

Internal Two Button Configuration Option

The Simple display has two buttons that can be used for Basic configuration such as re ranging, PV Engineering unit setting, Zero/Span settings and Loop testing and calibration functions.

Handheld Configuration

SmartLine transmitters feature two-way communication and configuration capability between the operator and the transmitter. All Honeywell transmitters are designed and tested for compliance with the offered communication protocols and are designed to operate with any Standards compliant handheld configuration device.

Personal Computer Configuration

Honeywell's SCT 3000 Configuration Toolkit provides an easy way to configure Digitally Enhanced (DE) instruments using a personal computer as the configuration interface. Field Device Manager (FDM) Software and FDM Express are also available for managing HART & Fieldbus device configurations.

Modular Design

To help contain maintenance & inventory costs, all ST 700 transmitters are modular in design supporting the user's ability to replace meter bodies, add indicators or change electronic modules without affecting overall performance or approval body certifications. Each meter body is uniquely characterized to provide in-tolerance performance over a wide range of application variations in temperature and pressure and due to the Honeywell advanced interface, electronic modules may be swapped with any electronics module without losing in-tolerance performance characteristics.

Modular Features

- Meter body replacement
- Exchange/replace electronics/comms modules*
- Add or remove integral indicator*
- Add or remove lightning protection (terminal connection)*

* Field replaceable in all electrical environments (including IS) except flameproof without violating agency approvals.

With no performance effects, Honeywell's unique modularity results in **lower inventory needs and lower overall operating costs.**

Performance Specifications

Reference Accuracy (conformance to +/-3 Sigma)

Table 1

Model	URL	LRL	Min Span	Maximum Turndown Ratio	Stability (% URL/Year for 10 years)	Reference Accuracy ^{1,2} (% Span) Standard/ optional
STD720	400 in H ₂ O (1000 mbar)	-400 in H ₂ O (-1000 mbar)	4 in H ₂ O (10 mbar)	100:1	0.020	0.05 / 0.04
STD730	100 psi (7.0 bar)	-100 psi (-7.0 bar)	1 psi (0.07 bar)	100:1	0.020	
STD770	3000 psi (210 bar)	-100 psi (-7.0 bar)	30 psi (2.1bar)	100:1	0.020	

Table 1

Zero and span may be set anywhere within the listed (URL/LRL) range limits

Accuracy at Specified Span, Temperature and Static Pressure Effects: (conformance to +/-3)

Table 2

	Model	URL	Accuracy ^{1,2} (% of Span)			Combined Zero & Span temperature Effect (% Span / 28°C (50°F))		Combined Zero & Span Static Line Pressure Effect (% Span/1000psi)		
			Reference Turndown	A	B	C (see URL units)	D	E	F	G
Standard Accuracy	STD720	400 in H ₂ O (1000 mbar)	16:1	0.005	0.045	25 (62.5)	0.050	0.020	0.100	0.010
	STD730	100 psi (7.0 bar)	4:1			25 (1.75)				
	STD770	3000 psi (210 bar)	10:1			300 (21)	0.065	0.010		
High Accuracy option	STD720	400 in H ₂ O (1000 mbar)	16:1	0.005	0.035	25 (62.5)	0.050	0.020	0.100	0.010
	STD730	100 psi (7.0 bar)	4:1			25 (1.75)				
	STD770	3000 psi (210 bar)	10:1			300 (21)	0.065	0.010		
Turn Down Effect						Temp Effect		Static Effect		
$\pm [A + B] \text{ if Span} \geq C$ $\pm \left[A + B \left(\frac{C}{\text{Span}} \right) \right] \text{ if Span} < C$						$\pm \left[D + E \left(\frac{\text{URL}}{\text{Span}} \right) \right]$		$\pm \left[F + G \left(\frac{\text{URL}}{\text{Span}} \right) \right]$		

Total Performance (% of Span):

$$\text{Total Performance} = \pm \sqrt{(\text{Accuracy})^2 + (\text{Temp Effect})^2 + (\text{Static Line Pressure Effect})^2}$$

Total Performance Examples (for comparison): standard accuracy, 5:1 Turndown, up to 50°F (28°C) shift & up to 1000 psi Static Pressure

STD720 @ 80 inH₂O: 0.218% of span

STD730 @ 20 psi: 0.199 % of span

STD770 @ 600 psi: 0.196 % of span

Typical Calibration Frequency:

Calibration verification is recommended every two (2) years

Notes:

1. Terminal Based Accuracy – Includes combined effects of linearity, hysteresis and repeatability. Analog output adds 0.005% of span
2. For zero based spans and reference conditions of: 25°C (77°F), 0 psig static pressure, 10 to 55% RH and 316SS barrier diaphragm.

Operating Conditions – All Models

Parameter	Reference Condition		Rated Condition		Operative Limits		Transportation and Storage	
	°C	°F	°C	°F	°C	°F	°C	°F
Ambient Temperature¹	25±1	77±2	-40 to 85	-40 to 185	-40 to 85	-40 to 185	-55 to 120	-67 to 248
Meter Body Temperature²	25±1	77±2	-40 to 110	-40 to 230	-40 to 125	-40 to 257	-55 to 120	-67 to 248
Humidity %RH	10 to 55		0 to 100		0 to 100		0 to 100	
Vac. Region – Min. Pressure								
mmHg absolute inH₂O absolute	Atmospheric Atmospheric		25 13		2 (short term) ³ 1 (short term) ³			
Supply Voltage Load Resistance	HART: 10.8 to 42.4 VDC at terminals (IS versions limited to 30 VDC), 0 to 1,440 ohms DE: 15 to 49.3VDC at terminals (IS versions limited to 30VDC), 0 to 1,200 ohms (as shown in Figure 2) FOUNDATION Fieldbus: 9.0 to 32.0 VDC at terminals, steady state current: 17.6mA, software download current: 27.4mA							
Maximum Allowable Working Pressure (MAWP)^{4,5} (ST 700 products are rated to Maximum Allowable Working Pressure. MAWP depends on Approval Agency and transmitter materials of construction.)	4,500 psi (310 bar)							

¹ LCD Display operating temperature -20°C to +70°C. Storage temperature -30°C to 80°C.

² Silicone 704 minimum temperature rating is 0°C (32°F). CTFE minimum temperature rating is -40°C (-40°F). NEOBEE® M-20 minimum temperature rating is -15°C (5°F). NEOBEE® is a registered trademark of Stepan Company.

³ Short term equals 2 hours at 70°C (158°F).

⁴ MAWP applies for temperatures -40 to 125°C. Static Pressure Limit is de-rated to 3,000 psi for -26°C to -40°C. for all models. Use of graphite o-rings de-rates transmitter to 3,625 psi. Use of 1/2:" process adaptors with graphite o-rings de-rates transmitter to 3,000 psi.

⁵ Consult factory for MAWP of ST 700 transmitters with CRN approval.

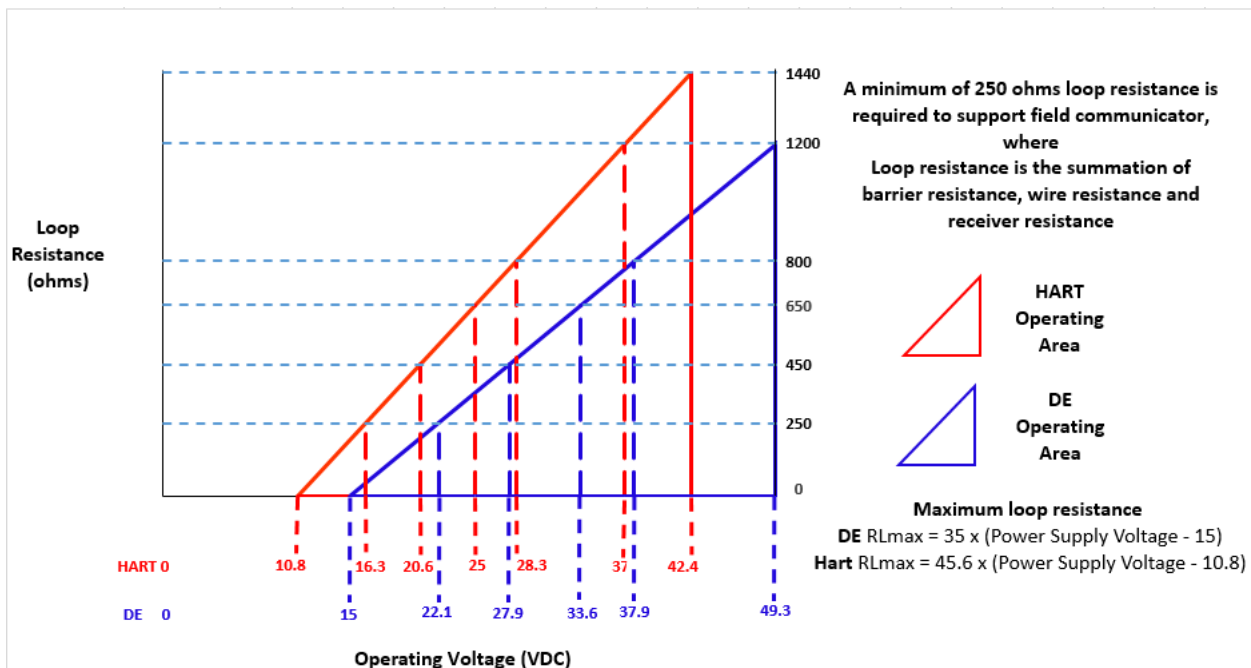

Figure 2 - Supply voltage and loop resistance chart & calculations

Performance Under Rated Conditions – All Models

Parameter	Description									
Analog Output Digital Communications:	Two-wire, 4 to 20 mA (HART & DE Transmitters only) Honeywell DE, HART protocol or FOUNDATION Fieldbus ITK 6.0.1 compliant All transmitters, irrespective of protocol have polarity insensitive connections.									
HART & DE Output Failure Modes (NAMUR for DE Units requires selecting display and configuration buttons or factory configuration)	<table border="0"> <thead> <tr> <th></th> <th>Honeywell Standard</th> <th>NAMUR NE 43 Compliance</th> </tr> </thead> <tbody> <tr> <td>Normal Limits:</td> <td>3.8 – 20.8 mA</td> <td>3.8 – 20.5 mA</td> </tr> <tr> <td>Failure Mode:</td> <td>≤ 3.6 mA and ≥ 21.0 mA</td> <td>≤ 3.6 mA and ≥ 21.0 mA</td> </tr> </tbody> </table>		Honeywell Standard	NAMUR NE 43 Compliance	Normal Limits:	3.8 – 20.8 mA	3.8 – 20.5 mA	Failure Mode:	≤ 3.6 mA and ≥ 21.0 mA	≤ 3.6 mA and ≥ 21.0 mA
	Honeywell Standard	NAMUR NE 43 Compliance								
Normal Limits:	3.8 – 20.8 mA	3.8 – 20.5 mA								
Failure Mode:	≤ 3.6 mA and ≥ 21.0 mA	≤ 3.6 mA and ≥ 21.0 mA								
Supply Voltage Effect	0.005% span per volt.									
Transmitter Turn on Time (includes power up & test algorithms)	HART or DE: 2.5 seconds Foundation Fieldbus: host dependent									
Response Time (delay + time constant)	<table border="0"> <thead> <tr> <th><u>DE/HART Analog Output</u></th> <th><u>FOUNDATION Fieldbus</u></th> </tr> </thead> <tbody> <tr> <td>100ms</td> <td>150ms (Host Dependent)</td> </tr> </tbody> </table>	<u>DE/HART Analog Output</u>	<u>FOUNDATION Fieldbus</u>	100ms	150ms (Host Dependent)					
<u>DE/HART Analog Output</u>	<u>FOUNDATION Fieldbus</u>									
100ms	150ms (Host Dependent)									
Damping Time Constant	HART: Adjustable from 0 to 32 seconds in 0.1 increments. Default: 0.50 seconds DE: Discrete values 0, .16, .32, .48, 1, 2, 4, 8, 16, 32 seconds. Default: 0.48 seconds									
Vibration Effect	Less than +/- 0.1% of URL w/o damping Per IEC60770-1 field or pipeline, high vibration level (10-2000Hz: 0.21 displacement/3g max acceleration)									
Electromagnetic Compatibility	IEC 61326-3-1									
Lightning Protection Option	Leakage Current: 10uA max @ 42.4VDC 93C Impulse rating: 8/20us 5000A (>10 strikes) 10000A (1 strike min.) 10/1000us 200A (> 300 strikes)									

Materials Specifications (see model selection guide for availability/restrictions with various models)

Parameter	Description
Barrier Diaphragms Material	316L SS, Hastelloy® C-276 ² , Monel® 400 ³ , Tantalum
Process Head Material	316 SS ⁴ , Carbon Steel (Zinc-plated) ⁵ , Hastelloy C-276 ⁶
Vent/Drain Valves & Plugs ¹	316 SS ⁴ , Hastelloy C-276 ²
Head Gaskets	Glass-filled PTFE standard. Viton® and graphite are optional.
Meter Body Bolting	Carbon Steel (Zinc plated) standard. Options include 316 SS, NACE A286 SS bolts, Monel K500, Super Duplex and B7M.
Optional Adapter Flange and Bolts	Adapter Flange materials include 316 SS, Hastelloy C-276 and Monel 400. Bolt material for flanges is dependent on process head bolts material chosen. Standard adaptor seal material is glass-filled PTFE. Viton and graphite are optional.
Mounting Bracket	2" Pipe, Carbon Steel (Zinc-plated) or 304 Stainless Steel or 316 Stainless Steel
Fill Fluid	Silicone 200, CTFE, NEOBEE M-20 or Silicone 704
Electronic Housing	Pure Polyester Powder Coated Low Copper (<0.4%)-Aluminum. Meets NEMA 4X, IP66, & IP67. All stainless steel housing is optional.
Mounting	Can be mounted in virtually any position using the standard mounting bracket. Bracket is designed to mount on 2-inch (50 mm) vertical or horizontal pipe. See Figure 3.
Process Connections	1/4- NPT or 1/2- NPT with adapter (meets DIN requirements)
Wiring	Accepts up to 16 AWG (1.5 mm diameter).
Dimensions	See Figure 4.
Net Weight	8.3 pounds (3.8 Kg) with Aluminum Housing.

¹ Vent/Drains are sealed with Teflon®

² Hastelloy C-276 or UNS N10276

³ Monel 400 or UNS N04400

⁴ Supplied as 316 SS or as Grade CF8M, the casting equivalent of 316 SS.

⁵ Carbon Steel heads are zinc-plated and not recommended for water service due to hydrogen migration. For that service, use 316 stainless steel wetted Process Heads.

⁶ Hastelloy C-276 or UNS N10276. Supplied as indicated or as Grade CW12MW, the casting equivalent of Hastelloy C-276

Communications Protocols & Diagnostics

HART Protocol

Version: HART 7

Foundation Fieldbus (FF)

Available Function Blocks

Block Type	Qty	Execution Time
Resource	1	n/a
Transducer	1	n/a
Diagnostic	1	n/a
Analog Input	1*	30 ms
PID w/Autotune	1	45 ms
Integrator	1	30 ms
Signal Char (SC)	1	30 ms
LCD Display	1	n/a
Flow Block	1	30 ms
Input Selector	1	30 ms
Arithmetic	1	30 ms

* AI block may have two (2) additional instantiations.

All available function blocks adhere to FOUNDATION Fieldbus standards. PID blocks support ideal & robust PID algorithms with full implementation of Auto-tuning.

Link Active Scheduler

Transmitters can perform as a backup Link Active Scheduler and take over when the host is disconnected. Acting as a LAS, the device ensures scheduled data transfers typically used for the regular, cyclic transfer of control loop data between devices on the Fieldbus.

Number of Devices/Segment

Entity IS model: 6 devices/segment

Schedule Entries

18 maximum schedule entries

Number of VCR's: 24 max

Compliance Testing: Tested according to ITK 6.0.1

Software Download

Utilizes Class-3 of the Common Software Download procedure as per FF-883 which allows the field devices of any manufacturer to receive software upgrades from any host.

Honeywell Digitally Enhanced (DE)

DE is a Honeywell proprietary protocol which provides digital communications between Honeywell DE enabled field devices and hosts.

Standard Diagnostics

ST 700 top level diagnostics are reported as either critical or non-critical and readable via the DD/DTM tools or integral display as shown below.

Critical Diagnostics

HART DD/DTM Tools	Basic Display	Simple Display
Electronic Module DAC Failure	Electronics module fault	Fault Comm EI
Meter Body NVM Corrupt	Meter Body fault	Fault Mtrbody
Config. Data Corrupt	Electronics module fault	Fault Comm EI
Electronic Module Diag Failure	Electronics module fault	Fault Comm EI
Meter Body Critical Failure	Meter Body fault	Fault Mtrbody
Sensor Comms Timeout	Meter Body Comm fault	Fault Mbd Com









Non-Critical Diagnostics

HART DD/DTM Tools
Display Failure
Electronic Module Comm Failure
Meter Body Excess Correct
Sensor Over Temperature
Fixed Current Mode
PV Out of Range
No Factory Calibration
No DAC Compensation
LRV Set Error – Zero Config. Button
URV Set Error – Zero Config. Button
AO Out of Range
Loop Current Noise
Meter Body Unreliable Comm
Tamper Alarm,
No DAC Calibration
Sensor Supply Voltage Low

Refer to ST 700 manuals for additional level diagnostic information

Hazardous Areal Certifications

MSG CODE	AGENCY	TYPE OF PROTECTION	COMM. OPTION	ELECTRICAL PARAMETERS	AMBIENT TEMP (Ta)
A	FM Approvals™ USA	Explosionproof: Class I, Division 1, Groups A, B, C, D; Dust Ignition Proof: Class II, III, Division 1, Groups E, F, G; T6..T5 Class I, Zone 0/1, AEx db IIC T6..T5 Ga/Gb Class II, Zone 21, AEx tb IIIC T95° Db	All	Note 1	T5: -50 °C to 85°C T6: -50 °C to 65°C
		Intrinsically Safe: Class I, II, III, Division 1, Groups A, B, C, D, E, F, G: T4 Class I, Zone 0, AEx ia IIC T4 Ga FISCO Field Device (Only for FF Option) Ex ia IIC T4 Ga; Ex ic IIC T4 Gc	4-20 mA / DE/ HART	Note 2a	-50 °C to 70°C
		Nonincendive: Class I, Division 2, Groups A, B, C, D locations, T4 Class I, Zone 2, AEx nA IIC T4 Gc	Foundation Fieldbus	Note 2b	-50 °C to 70°C
		Nonincendive: Class I, Division 2, Groups A, B, C, D locations, T4 Class I, Zone 2, AEx nA IIC T4 Gc	4-20 mA / DE/ HART/ Foundation Fieldbus	Note 1	-50 °C to 85°C
		Enclosure: Type 4X/ IP66/ IP67	All	All	-
		STANDARDS: FM Class 3600:2011; FM Class 3610: 2010; FM Class 3611: 2004; FM Class 3615: 2006; FM Class 3616: 2011; FM Class 3810: 2005; ANSI/ISA 60079-0: 2013; ANSI/UL 60079-1: 2015; ANSI/UL 60079-11: 2014; ANSI/ISA 60079-15: 2012; ANSI/UL 60079-26: 2017; ANSI/UL 60079-31: 2015; ANSI/NEMA 250: 2003; ANSI/ IEC 60529: 2004			
B	Canadian Standards Association (CSA) USA and Canada	Explosion Proof: Class I, Division 1, Groups A, B, C, D; Class II, Division 1, Groups E, F, G; Class III, Division 1, T6..T5 Class I Zone 1 AEx db IIC T6..T5 Ga/Gb Ex db IIC T6..T5 Ga/Gb Zone 22 AEx tb IIIC T95° Db Ex tb IIIC T95° Db	All	Note 1	T5: -50°C TO 85°C T6: -50°C TO 65°C
		Intrinsically Safe: Class I, II, III, Division 1, Groups A, B, C, D; Class II, Division 1, Groups E, F, G; Class III, Division 1, T4 Class I Zone 0, AEx ia IIC T4 Ga Class I Zone 2, AEx ic IIC T4 Gc Ex ia IIC T4 Ga Ex ic IIC T4 Gc FISCO Field Device (Only for FF Option) Ex ia IIC T4 Ga; Ex ic IIC T4 Gc	4-20 mA / DE/ HART	Note 2	-50°C TO 70°C
		Nonincendive: Class I, Division 2, Groups A, B, C, D; Class II, Division 2, Groups F, G; Class III, Division 2, T4 Class I Zone 2 AEx nA IIC T4 Gc Ex nA IIC T4 Gc	Foundation Fieldbus	Note 2	-50°C TO 70°C
		Nonincendive: Class I, Division 2, Groups A, B, C, D; Class II, Division 2, Groups F, G; Class III, Division 2, T4 Class I Zone 2 AEx nA IIC T4 Gc Ex nA IIC T4 Gc	4-20 mA / DE/ HART/ Foundation Fieldbus	Note 1	-50°C to 85°C
		Enclosure: Type 4X/ IP66/ IP67	All	All	-

MSG CODE	AGENCY	TYPE OF PROTECTION	COMM. OPTION	ELECTRICAL PARAMETERS	AMBIENT TEMP (Ta)
		STANDARDS: CSA C22.2 No. 0-10; CSA C22.2 No. 94-M91; CSA C22.2 No. 25-1966; CSA C22.2 No. 30-M1986; CSA C22.2 No. 142-M1987; CSA C22.2 No. 157-92; CSA C22.2 No. 213-M1987; CSA-C22.2 No. 60529:05; CSA-C22.2 No. 60079-0:11; CSA-C22.2 No. 60079-1:11; CSA-C22.2 No. 60079-11:11; CSA-C22.2 No. 60079-15:12; CSA-C22.2 No. 60079-31:12; ISA 12.12.01-2010; ISA 60079-0: 2009; ISA 60079-11: 2011; ISA 60079-15: 2009; ISA 60079-26: 2008; ISA-60079-27:2007 (12.02.04)-2006 (R2011); UL 913 Ed. 6; UL 916:1998; ANSI/ISA-12.27.01-2011			
C	ATEX	Flameproof: SIRA 12ATEX2233X  II 1/2 G Ex db IIC T6..T5 Ga/Gb II 2 D Ex tb IIIC T95°C...T120°C Db	All	Note 1	T5: -50°C TO 85°C T6: -50°C TO 65°C
		Intrinsically Safe: SIRA 12ATEX2233X  II 1 G Ex ia IIC T4 Ga II 2 D Ex ia IIIC T125°C Db FISCO Field Device (Only for FF Option) II 1 G Ex ia IIC T4 Ga	4-20 mA / DE/ HART	Note 2	-50°C TO 70°C
		Zone 2, Increase Safety: SIRA 12ATEX4234X  II 3 G Ex ec IIC T4 Gc	4-20 mA / DE/ HART/	Note 1	-50°C TO 85°C
		Zone 2, Intrinsically Safe: SIRA 12ATEX4234X  II 3 G Ex ic IIC T4 Gc FISCO Field Device (Only for FF Option) II 3 G Ex ic IIC T4 Gc	4-20 mA / DE/ HART/ Foundation Fieldbus	Note 2	-50°C TO 85°C
		Enclosure: IP66/ IP67	All	All	-
		STANDARDS: EN 60079-0: 2018; EN 60079-1: 2014; EN 60079-7: 2015+A1:2018; EN 60079-11: 2012; EN 60079-26: 2015; EN 60079-31: 2014			
	UKEx	Flameproof: CSAE 22UKEX1021X  II 1/2 G Ex db IIC T6..T5 Ga/Gb II 2 D Ex tb IIIC T95°C...T120°C Db	All	Note 1	T5: -50°C TO 85°C T6: -50°C TO 65°C
		Intrinsically Safe: CSAE 22UKEX1021X  II 1 G Ex ia IIC T4 Ga II 2 D Ex ia IIIC T125°C Db FISCO Field Device (Only for FF Option) II 1 G Ex ia IIC T4 Ga	4-20 mA / DE/ HART	Note 2	-50°C TO 70°C
		Zone 2, Increase Safety: CSAE 22UKEX1008X  II 3 G Ex ec IIC T4 Gc	4-20 mA / DE/ HART/	Note 1	-50°C TO 85°C
		Zone 2, Intrinsically Safe: CSAE 22UKEX1009X  II 3 G Ex ic IIC T4 Gc FISCO Field Device (Only for FF Option) II 3 G Ex ic IIC T4 Gc	4-20 mA / DE/ HART/ Foundation Fieldbus	Note 2	-50°C TO 85°C
		Enclosure: IP66/ IP67	All	All	-

MSG CODE	AGENCY	TYPE OF PROTECTION	COMM. OPTION	ELECTRICAL PARAMETERS	AMBIENT TEMP (Ta)
		STANDARDS: EN 60079-0: 2018; EN 60079-1: 2014; EN 60079-7: 2015+A1:2018; EN 60079-11: 2012; EN 60079-26: 2015; EN 60079-31: 2014			
D	IECEX World	Flameproof: IECEx SIR 12.0100X Ex db IIC T6..T5 Ga/Gb Ex tb IIIC T95°C...T120°C Db	All	Note 1	T5: -50°C TO 85°C T6: -50°C TO 65°C
		Intrinsically Safe: IECEx SIR 12.0100X Ex ia IIC T4 Ga Ex ia IIIC T125°C Db FISCO Field Device (Only for FF Option) Ex ia IIC T4 Ga; Ex ic IIC T4 Gc	4-20 mA / DE/ HART	Note 2	-50°C TO 70°C
			Foundation Fieldbus	Note 2	-50°C TO 70°C
		Zone 2, Increase Safety: IECEx SIR 12.0100X Ex ec IIC T4 Gc	4-20 mA / DE/ HART/ Foundation Fieldbus	Note 1	-50°C TO 85°C
		Zone 2, Intrinsically Safe: IECEx SIR 12.0100X Ex ic IIC T4 Gc FISCO Field Device (Only for FF Option) Ex ic IIC T4 Gc	4-20 mA / DE/ HART/ Foundation Fieldbus	Note 2	-50°C TO 85°C
		Enclosure: IP66/ IP67	All	All	-
STANDARDS: IEC 60079-0: 2017; IEC 60079-1: 2014; IEC 60079-7: 2017; IEC 60079-11: 2011; IEC 60079-26: 2014; IEC 60079-31: 2013					

E	SAEx South Africa	Flameproof : Ex d IIC T6...T5 Ga/Gb Ex tb IIIC T95°C...T120°C Db	All	Note 1	T5: -50°C TO 85°C T6: -50°C TO 65°C
		Intrinsically Safe: Ex ia IIC Ga T4 FISCO Field Device (Only for FF Option) Ex ia IIC T4 Ga; Ex ic IIC T4 Gc	4-20 mA / DE/ HART	Note 2	-50°C TO 70°C
			Foundation Fieldbus	Note 2	-50°C TO 70°C
		Zone 2, Increase Safety: II 3 G Ex ec IIC T4 Gc	4-20 mA / DE/ HART/ Foundation Fieldbus	Note 1	-50°C TO 85°C
		Zone 2, Intrinsically Safe: Ex ic IIC T4 Gc FISCO Field Device (Only for FF Option) Ex ic IIC T4 Gc	4-20 mA / DE/ HART/ Foundation Fieldbus	Note 2	-50°C TO 85°C
Enclosure: IP66/ IP67		All	All	-	
F	INMETRO Brazil	Flameproof: Ex db IIC T6..T5 Ga/Gb Ex tb IIIC T95°C...T120°C Db	All	Note 1	T5: -50°C TO 85°C T6: -50°C TO 65°C
		Intrinsically Safe: Ex ia IIC T4 Ga FISCO Field Device (Only for FF Option) Ex ia IIC T4 Ga; Ex ic IIC T4 Gc	4-20 mA / DE/ HART	Note 2a	-50°C TO 70°C
			Foundation Fieldbus	Note 2b	-50°C TO 70°C
		Zone 2, Increase Safety: II 3 G Ex ec IIC T4 Gc	4-20 mA / DE/ HART/ Foundation Fieldbus	Note 1	-50°C TO 85°C
		Zone 2, Intrinsically Safe: Ex ic IIC T4 Gc FISCO Field Device (Only for FF Option) Ex ic IIC T4 Gc	4-20 mA / DE/ HART/ Foundation Fieldbus	Note 2	-50°C TO 85°C
		Enclosure : IP 66/67		All	All
G	NEPSI CHINA	Flameproof: Ex db IIC T6..T5 Ga/Gb Ex tb IIIC T 95°C Db	All	Note 1	T5: -50°C TO 85°C T6: -50°C TO 65°C
		Intrinsically Safe: Ex ia IIC T4 Ga FISCO Field Device (Only for FF Option) Ex ia IIC T4 Ga; Ex ic IIC T4 Gc	4-20 mA / DE/ HART	Note 2	-50°C TO 70°C
			Foundation Fieldbus	Note 2	-50°C TO 70°C
		Zone 2, Increase Safety: II 3 G Ex ec IIC T4 Gc	4-20 mA / DE/ HART/ Foundation Fieldbus	Note 1	-50°C TO 85°C
		Zone 2, Intrinsically Safe: Ex ic IIC T4 Gc FISCO Field Device (Only for FF Option) Ex ic IIC T4 Gc	4-20 mA / DE/ HART/ Foundation Fieldbus	Note 2	-50°C TO 85°C
		Enclosure : IP 66/67		All	All

H	KOSHA Korea	Flameproof : Ex d IIC T4, T5, T6 Ex tD A21 IP66/IP67 T95°C...T120°C	All	Note 1	T4: -50°C TO 85°C T5: -50°C TO 85°C T6: -50°C TO 65°C
		Intrinsically Safe: Ex ia IIC T4	4-20 mA / DE/ HART	Note 2	Ta= -50 °C to 70°C
			Foundation Fieldbus	Note 2	Ta= -50 °C to 70°C
Enclosure: IP66/ IP67		All	All	-	
I	EAC Russia, Belarus and Kazakhstan	Flameproof: Ga/Gb Ex d IIC T6..T5 Ex tb IIIC Db T 85°C	All	Note 1	T5: -50°C TO 85°C T6: -50°C TO 65°C
		Intrinsically Safe: Ga Ex ia IIC T4 X FISCO Field Device (Only for FF Option) Ga Ex ia IIC T4 X	4-20 mA / DE/ HART	Note 2	-50°C TO 70°C
			Foundation Fieldbus	Note 2	-50°C TO 70°C
		Zone 2, Non Sparking: 2 Ex nA IIC T4 Gc X	4-20 mA / DE/ HART/ Foundation Fieldbus	Note 1	-50°C TO 85°C
		Zone 2, Intrinsically Safe: Ga Ex ic IIC T4 X FISCO Field Device (Only for FF Option) 2 Ex ic IIC T4 Gc X	4-20 mA / DE/ HART/ Foundation Fieldbus	Note 2	-50°C TO 85°C
Enclosure : IP 66/67		All	All		
J	CCoE INDIA	Flameproof: Ex d IIC T6..T5 Ga/Gb	All	Note 1	T5: -50°C TO 85°C T6: -50°C TO 65°C
		Intrinsically Safe: Ex ia IIC T4 Ga FISCO Field Device (Only for FF Option) Ex ia IIC T4 Ga; Ex ic IIC T4 Gc	4-20 mA / DE/ HART	Note 2	-50°C TO 70°C
			Foundation Fieldbus	Note 2	-50°C TO 70°C
		Non Sparking Ex nA IIC T4 Gc	4-20 mA / DE/ HART/ Foundation Fieldbus	Note 1	-50°C TO 85°C
Enclosure: IP66/ IP67		All	All	-	
K	UATR UKRAINE	Flameproof: II 1/2 G Ex db IIC T6..T5 Ga/Gb II 2 D Ex tb IIIC T95°C...T120°C Db	All	Note 1	T5: -50°C TO 85°C T6: -50°C TO 65°C
		Intrinsically Safe: II 1 G Ex ia IIC T4 Ga FISCO Field Device (Only for FF Option) II 1 G Ex ia IIC T4 Ga	4-20 mA / DE/ HART	Note 2	-50°C TO 70°C
			Foundation Fieldbus	Note 2	-50°C TO 70°C
Enclosure: IP66/ IP67		All	All	-	

Mounting & Dimensional Drawings

Reference Dimensions: $\frac{\text{millimeters}}{\text{inches}}$

Mounting Configurations

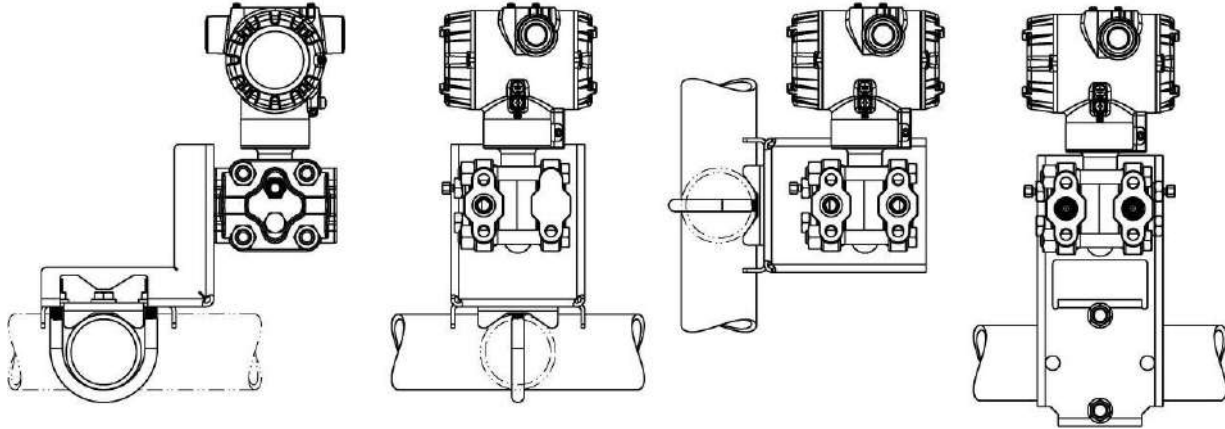

Figure 3 – Typical mounting configurations of STD720, STD730 & STD770 for reference only

Dimensions

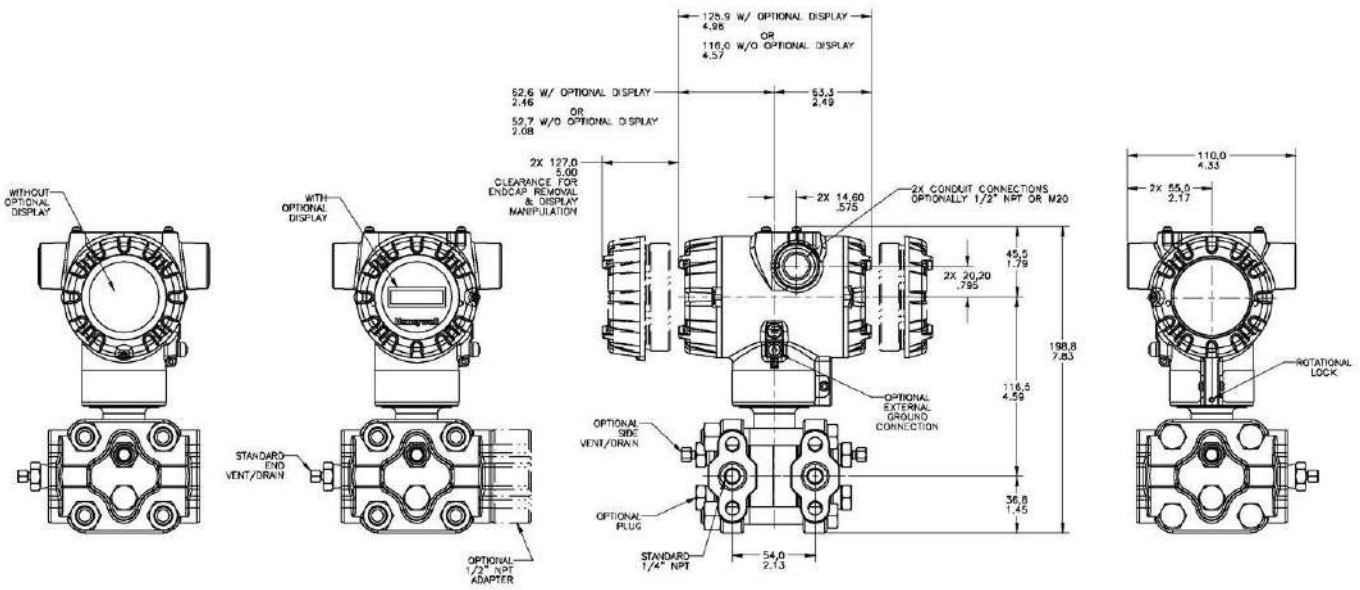

Figure 4 – Typical mounting dimensions of STD720, STD730 & STD770 for reference only

Model Selection Guide

Model Selection Guides are subject to change and are inserted into the specifications as guidance only.

**Model STD700
Differential Pressure Transmitter**

Model Selection Guide:
34-ST-16-101 Issue 26

Instructions: Make selections from all Tables: Key through XIII using column below the proper arrow. Asterisk indicates availability. Letter (a) refer to restrictions highlighted in the restrictions table. Tables delimited with dashes.

Key - I - II - III - IV - V - VI - VII - VIII - IX

KEY NUMBER	URL	LRL	Max Span	Min Span	Units
a. Measurement Range	400/(1000)	-400/(-1000)	400/(1000)	4.0 (10)	" H ₂ O (mbar)
	100 (7.0)	-100 (-7.0)	100 (7.0)	1 (0.07)	psi (bar)
	3000 (210)	-100 (-7.0)	3000 (210)	30 (2.1)	psi (bar)

Selection	Availability
STD720	↓
STD730	↓
STD770	↓

TABLE I		METER BODY SELECTIONS			
a. Process Wetted Heads & Diaphragm Materials	Process Head Material		Diaphragm Material		
	Plated Carbon Steel		316L Stainless Steel Hastelloy® C-276 Monel® 400 Tantalum		
	316 Stainless Steel		316L Stainless Steel Hastelloy C-276 Monel 400 Tantalum		
	Hastelloy C-276		Hastelloy C-276 Tantalum		
	Monel 400		Monel® 400		
b. Fill Fluid	Silicone Oil 200 Fluorinated Oil CTFE Silicone Oil 704 NEOBEE® M-20				
c. Process Connection	None 1/2" NPT female	None (1/4" NPTF female thread Std) Materials to Match Head & Head Bolt Materials Selections ¹			
d. Bolt/Nut Materials	Carbon Steel 316 SS Grade 660 (NACE A286) with NACE 304 SS Nuts Grade 660 (NACE A286) Bolts & Nuts Monel K500 Super Duplex B7M				
e. Vent/Drain Type/Location	Head Type	Vent Type	Location	Vent Material	
	Single Ended	None	None	None	
	Single Ended	Standard Vent	Side	Matches Head Material ¹	
	Single Ended	Center Vent	Side	Stainless Steel Only	
	Dual Ended	Standard Vent	End	Matches Head Material ¹	
	Dual Ended	Center Vent	End	Stainless Steel Only	
Dual Ended	Std Vent/Plug	Side/End	Matches Head Material ¹		
f. Gasket Material	Teflon® or PTFE (Glass Filled) Viton® or Fluorocarbon Elastomer Graphite				
g. Static Pressure	Standard Static Pressure - 4500 psig (315 bar)				

A	*	*	*
B	*	*	*
C	*	*	*
D	a	a	a
E	*	*	*
F	*	*	*
G	*	*	*
H	a	a	a
J	*	*	*
K	a	a	a
L	a	a	a
1	*	*	*
2	*	*	*
3	*	*	*
4	*	*	*
A	*	*	*
H	*	*	*
C	*	*	*
S	*	*	*
N	*	*	*
K	p	p	p
M	p	p	p
D	p	p	p
B	*	*	*

1	*	*	*
2	*	*	*
3	t	t	t
4	*	*	*
5	t	t	t
6	*	*	*
A	*	*	*
B	*	*	*
C	*	*	*
S	*	*	*

¹Except Carbon Steel Heads shall use 316SS Vent/Drain, Plugs & Adapters when required

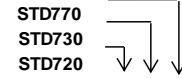
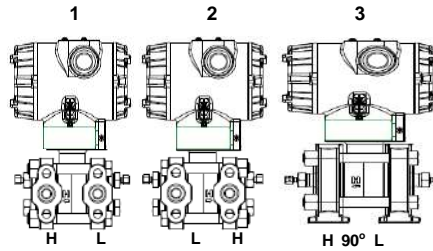

TABLE II		Meter Body & Connection Orientation
Head/Connect Orientation	Standard	High Side Left, Low Side Right ² / Std Head Orientation
	Reversed	Low Side Left, High Side Right ² / Std Head Orientation
	90/Standard	High Side Left, Low Side Right ² / 90° Head Rotation

1	*	*	*
2	*	*	*
3	h	h	h

TABLE III		Agency Approvals (see data sheet for Approval Code Details)
Approvals	No Approvals Required	
	FM Explosion proof, Intrinsically Safe, Non-incendive, & Dustproof	
	CSA Explosion proof, Intrinsically Safe, Non-incendive, & Dustproof	
	ATEX Explosion proof, Intrinsically Safe & Non-incendive	
	IECEX Explosion proof, Intrinsically Safe & Non-incendive	
	SAEx Explosion proof, Intrinsically Safe & Non-incendive	
	INMETRO Explosion proof, Intrinsically Safe & Non-incendive	
	NEPSI Explosion proof, Intrinsically Safe & Non-incendive	
	KOSHA Explosion proof, Intrinsically Safe & Non-incendive	
	EAC Customs Union (Russia,Belarus,Kazakhstan) Ex Approval Flame proof, Intrinsically Safe	
	ATEX/IECEX Explosion proof, Intrinsically Safe & Non-incendive	
	CCoE Explosion proof, Intrinsically Safe & Non-incendive	
	UATR Flameproof, Intrinsically Safe & Dustproof	

0	*	*	*
A	*	*	*
B	*	*	*
C	*	*	*
D	*	*	*
E	*	*	*
F	*	*	*
G	*	*	*
H	*	*	*
I	*	*	*
1	*	*	*
J	*	*	*
K	*	*	*

TABLE IV				TRANSMITTER ELECTRONICS SELECTIONS
a. Electronic Housing Material & Connection Type	Material	Connection	Lightning Protection	
	Polyester Powder Coated Aluminum	1/2 NPT	None	
	Polyester Powder Coated Aluminum	M20	None	
	Polyester Powder Coated Aluminum	1/2 NPT	Yes	
	Polyester Powder Coated Aluminum	M20	Yes	
	316 Stainless Steel (Grade CF8M)	1/2 NPT	None	
	316 Stainless Steel (Grade CF8M)	M20	None	
	316 Stainless Steel (Grade CF8M)	1/2 NPT	Yes	
316 Stainless Steel (Grade CF8M)	M20	Yes		
b. Output/ Protocol	Analog Output		Digital Protocol	
	4-20mA dc		HART Protocol	
	4-20mA dc		DE Protocol	
n/a		Foundation Fieldbus		
c. Customer Interface Selections	Indicator	Ext Zero, Span & Config Buttons	Languages	
	None	None	None	
	None	Yes (Zero/Span Only)	None	
	Basic	None	English	
	Basic	Yes	English	
	Standard (w/internal Zero, Span & Conf Buttons)	None	English	

A__	*	*	*
B__	*	*	*
C__	*	*	*
D__	*	*	*
E__	*	*	*
F__	*	*	*
G__	*	*	*
H__	*	*	*

H	*	*	*
D	*	*	*
F	*	*	*

__0	*	*	*
__A	f	f	f
__B	*	*	*
__C	*	*	*

__D	u	u	u
-----	---	---	---

TABLE V				CONFIGURATION SELECTIONS
a. Application Software	Diagnostics			
	Standard Diagnostics			
b. Output Limit, Failsafe & Write Protect Settings	Write Protect	Fail Mode	High & Low Output Limits ³	
	Disabled	High> 21.0mAdc	Honeywell Std (3.8 - 20.8 mAdc)	
	Disabled	Low< 3.6mAdc	Honeywell Std (3.8 - 20.8 mAdc)	
	Enabled	High> 21.0mAdc	Honeywell Std (3.8 - 20.8 mAdc)	
	Enabled	Low< 3.6mAdc	Honeywell Std (3.8 - 20.8 mAdc)	
	Enabled	N/A	Fieldbus	
c. General Configuration	Factory Standard			
	Custom Configuration (Unit Data Required from customer)			

1__	*	*	*
-----	---	---	---

1	f	f	f
2	f	f	f
3	f	f	f
4	f	f	f
5	g	g	g
6	g	g	g

__S	*	*	*
__C	*	*	*

² Left side/Right side as view ed from the customer connection perspective

³ NAMUR Output Limits 3.8 - 20.5mAdc can be configured by the customer or select custom configuration Table Vc

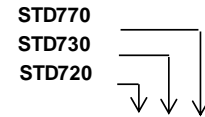

TABLE VI CALIBRATION & ACCURACY SELECTIONS			
	Accuracy	Calibrated Range	Calibration Qty
a. Accuracy and Calibration	Standard	Factory Std	Single Calibration
	Standard	Custom (Unit Data Required)	Single Calibration
	High Accuracy	Factory Std	Single Calibration
	High Accuracy	Custom (Unit Data Required)	Single Calibration

A	*	*	*
B	*	*	*
E	s	s	s
F	s	s	s

TABLE VII ACCESSORY SELECTIONS		
	Bracket Type	Material
a. Mounting Bracket	None	None
	Angle Bracket	Carbon Steel
	Angle Bracket	304 SS
	Angle Bracket	316 SS
	Marine Approved Bracket	Carbon Steel
	Marine Approved Bracket	304 SS
	Flat Bracket	Carbon Steel
	Flat Bracket	304 SS
	Flat Bracket	316 SS
b. Customer Tag	Customer Tag Type	
	No customer tag	
	One Wired Stainless Steel Tag (Up to 4 lines 26 char/line)	
c. Unassembled Conduit Plugs & Adapters	Unassembled Conduit Plugs & Adapters	
	No Conduit Plugs or Adapters Required	
	1/2 NPT Male to 3/4 NPT Female 316 SS Certified Conduit Adapter	
	1/2 NPT 316 SS Certified Conduit Plug	
	M20 316 SS Certified Conduit Plug	
	Minifast® 4 pin (1/2 NPT) (not suitable for X-Proof applications)	

0 ___	*	*	*
1 ___	*	*	*
2 ___	*	*	*
3 ___	*	*	*
8 ___	*	*	*
4 ___	*	*	*
5 ___	*	*	*
6 ___	*	*	*
7 ___	*	*	*

_ 0 _ _	*	*	*
_ 1 _ _	*	*	*
_ 2 _ _	*	*	*

_ _ A0	*	*	*
_ _ A2	n	n	n
_ _ A6	n	n	n
_ _ A7	m	m	m
_ _ A8	n	n	n
_ _ A9	m	m	m

TABLE VIII OTHER Certifications & Options: (String in sequence comma delimited (XX, XX, XX,....))	
Certifications & Warranty	None - No additional options
	NACE MR0175; MR0103; ISO15156 (FC33338) Process wetted parts only
	NACE MR0175; MR0103; ISO15156 (FC33339) Process wetted and non-wetted parts
	Marine (DNV, ABS, BV, KR, LR)
	EN10204 Type 3.1 Material Traceability (FC33341)
	Certificate of Conformance (F3391)
	Calibration Test Report & Certificate of Conformance (F3399)
	Certificate of Origin (F0195)
	FMEDA (SIL 2/3) Certification (FC33337)
	Over-Pressure Leak Test Certificate (1.5X MAWP) (F3392)
	Cert Clean for O ₂ or CL ₂ service per ASTM G93
	PMI Certification ¹
	Extended Warranty Additional 1 year
	Extended Warranty Additional 2 years
	Extended Warranty Additional 3 years
Extended Warranty Additional 4 years	

00	*	*	*	
FG	*	*	*	b
F7	c	c	c	
MT	d	d	d	
FX	*	*	*	
F3	*	*	*	b
F1	*	*	*	
F5	*	*	*	
FE	j	j	j	
TP	*	*	*	
OX	e	e	e	
PM	*	*	*	
01	*	*	*	
02	*	*	*	b
03	*	*	*	
04	*	*	*	

TABLE IX Manufacturing Specials	
Factory	Factory Identification

0000	*	*	*
------	---	---	---

MODEL RESTRICTIONS

Restriction Letter	Available Only with		Not Available with	
	Table	Selection(s)	Table	Selection(s)
a			VIII	F7, FG
c	1d	___ N,K,D,B ___	Ia	D,H,K,L ___
d	IVa	C, D,G,H ___	VIIa	1,2,3,5,6,7 ___
e	Ib	_ 2 _____		
f			IVb	_ F _
g			IVb	_ H, D _
h			Ie	4, 5, 6
			VIIa	1,2,3,4,5,6,7,8 ___
j	IVb	_ H _	Vb	_ 1,2,6 _
m	IVa	B, D, F, H ___		
n	IVa	A, C, E, G ___		
p			III	B- No CRN number available
s	Ia	A, E _____		
t			Ia	J, K, L _____
u	IVb	_ H		
b	Select only one option from this group			

¹The PMoption is available on all Smartline Pressure Transmitter process wetted parts such as process heads, flanges, bushings and vent plugs except plated carbon steel process heads and flanges. PMoption information is also available on diaphragms except STG and STA in-line construction pressure transmitters.

FIELD INSTALLABLE REPLACEMENT PARTS

Description	Kit Number
Integrally Mounted Basic Indicator Kit (Compatible with all Electronic Modules)	50049911-501
Terminal Strip w/Lightning Protection Kit for HART or DE Modules	50075472-532
Terminal Strip w/Lightning Protection Kit for FFB Module	50075472-534
Terminal Strip w/o Lightening Protection for HART or DE Modules	50075472-533
Terminal Strip w/o Lightening Protection FFB Module	50075472-531
HART Electronics Module	50049849-501
HART Electronics Module w/connection for external configuration buttons	50049849-502
DE Electronics Module	50049849-503
DE Electronics Module w/connection for external configuration buttons	50049849-504
FFB Electronics Module Kit	50049849-509
FFB Electronics Module w/connection for external configuration buttons	50049849-510
Standard Display Module	50126003-501

PRODUCT MANUALS

Description	Part Number
Product Manual ST 700 Smart Transmitter User Manual - English	34-ST-25-44
Product Manual ST 700 Smart Transmitter HART/DE Communications Manual - English	34-ST-25-47
Product Manual ST 700 Smart Transmitter Safety Manual - English	34-ST-25-37
Product Manual ST 700 Smart Transmitter Foundation Fieldbus Manual - English	34-ST-25-48
Product Manual ST 700 Smart Transmitter Function Block Manual - English	34-ST-25-49

All product documentation is available at www.honeywellprocess.com.

Sales and Service

For application assistance, current specifications, ordering, pricing, and name of the nearest Authorized Distributor, contact one of the offices below.

ASIA PACIFIC

Honeywell Process Solutions,
Phone: + 800 12026455 or
+44 (0) 1202645583
(TAC) hfs-tac-support@honeywell.com

Australia

Honeywell Limited
Phone: +(61) 7-3846 1255
FAX: +(61) 7-3840 6481
Toll Free 1300-36-39-36
Toll Free Fax:
1300-36-04-70

China – PRC - Shanghai

Honeywell China Inc.
Phone: (86-21) 5257-4568
Fax: (86-21) 6237-2826

Singapore

Honeywell Pte Ltd.
Phone: +(65) 6580 3278
Fax: +(65) 6445-3033

South Korea

Honeywell Korea Co Ltd
Phone: +(822) 799 6114
Fax: +(822) 792 9015

EMEA

Honeywell Process Solutions,
Phone: + 800 12026455 or
+44 (0) 1202645583

Email: (Sales)

FP-Sales-Apps@Honeywell.com

or

(TAC)

hfs-tac-support@honeywell.com

Web

Knowledge Base search
engine <http://bit.ly/2N5Vldi>

AMERICAS

Honeywell Process Solutions,
Phone: (TAC) (800) 423-9883
or (215) 641-3610
(Sales) 1-800-343-0228

Email: (Sales)

FP-Sales-Apps@Honeywell.com

or

(TAC)

hfs-tac-support@honeywell.com

Web

Knowledge Base search
engine <http://bit.ly/2N5Vldi>

Specifications are subject to change without notice.

For more information

To learn more about SmartLine Pressure Transmitters visit

www.process.honeywell.com

Or contact your Honeywell Account Manager

Process Solutions

Honeywell
1250 W Sam Houston Pkwy S
Houston, TX 77042

Honeywell Control Systems Ltd
Honeywell House, Skimped Hill Lane
Bracknell, England, RG12 1EB

Shanghai City Centre, 100 Jungi Road
Shanghai, China 20061

www.process.honeywell.com

Honeywell

34-ST-03-101

April 2023

©2023 Honeywell International Inc.