

Micro Motion™ F-Series Flow and Density Meters



High accuracy real world performance

- Best-in-class performance on liquid mass flow, volume flow, and density measurements in a compact design (up to $\pm 0.05\%$ liquid mass accuracy and up to $\pm 0.5 \text{ kg/m}^3$ liquid density accuracy)
- Rugged design minimizing process, mounting, and environmental effects

[VIEW PRODUCT >](#)

Best fit-for-application

- Cleanable, self-draining design for critical process control service
- Compact design enables installation flexibility
- Broad range of I/O offerings including HART™, Profibus-DP, FOUNDATION™ fieldbus, 4-20 mA, and wireless capabilities

Exceptional reliability and safety

- No moving parts to wear or replace minimizes maintenance for long-term reliability
- 316L stainless steel and nickel alloy C22 wetted parts construction for compatibility with most fluids
- Robust sensor design

Micro Motion F-Series flow and density meters

Micro Motion F-Series meters deliver superb measurement with exceptional flow and density performance as well as outstanding reliability for use in critical process control environments.

Optimal flow and density fit for critical process applications

- High performance rugged measurement in a compact drainable design that maximizes process up time
- Low frequency, high sensitivity fit-and-forget meter provides robust measurements even under demanding process conditions
- Multiple line sizes provide an ideal platform for batching, distribution, allocation and intra-plant measurement applications

Smart Meter Verification™: advanced diagnostics for your entire system

- Included as standard, with the option to license flow range detection and other advanced meter health diagnostics
- A comprehensive test that can be scheduled, run locally, or from the control room to provide confidence in your meter functionality and performance
- Verifies that your meter performs as well as the day it was installed, giving you assurance in less than 90 seconds
- Saves significant expenditure by reducing labor and extending or eliminating calibration intervals without interrupting the process

Industry-leading capabilities that unleash your process potential

- Available with the most extensive offering of transmitter and mounting options for maximum compatibility with your system
- State of the art, ISO/IEC 17025 compliant calibration stands achieving $\pm 0.014\%$ uncertainty drive best in class measurement accuracy
- The most comprehensive communication protocol offering in the industry including Smart Wireless
- True multi-variable technology measures necessary flow and density process variables simultaneously

Widest range of installation and process condition flexibility

- Featuring a low pressure drop, low weight design that reduces installation and commissioning costs
- Unmatched MVD™ transmitter technology with digital signal processing (DSP) delivers the fastest response rates enabling accurate batch and process measurement
- Design flexibility enables operation at high temperature up to 662 °F (350 °C) or high pressure up to 6,237 psig (430 barg) to solve your toughest measurement challenges

Access information when you need it with asset tags

Newly shipped devices include a unique QR code asset tag that enables you to access serialized information directly from the device. With this capability, you can:

- Access device drawings, diagrams, technical documentation, and troubleshooting information in your MyEmerson account
- Improve mean time to repair and maintain efficiency
- Ensure confidence that you have located the correct device
- Eliminate the time-consuming process of locating and transcribing nameplates to view asset information

Measurement principles

As a practical application of the Coriolis effect, the Coriolis mass flow meter operating principle involves inducing a vibration of the flow tube through which the fluid passes. The vibration, though it is not completely circular, provides the rotating reference frame which gives rise to the Coriolis effect. While specific methods vary according to the design of the flow meter, sensors monitor and analyze changes in frequency, phase shift, and amplitude of the vibrating flow tubes. The changes observed represent the mass flow rate and density of the fluid.

Mass and volume flow measurement

The measuring tubes are forced to oscillate producing a sine wave. At zero flow, the two tubes vibrate in phase with each other. When flow is introduced, the Coriolis forces cause the tubes to twist resulting in a phase shift. The time difference between the waves is measured and is directly proportional to the mass flow rate. Volume flow rate is calculated from mass flow rate and the density measurement.

Watch this video to learn more about how a Coriolis flow meter measures mass flow and density (click the link and select **View Videos**): <https://www.emerson.com/en-us/automation/measurement-instrumentation/flow-measurement/coriolis-flow-meters>.

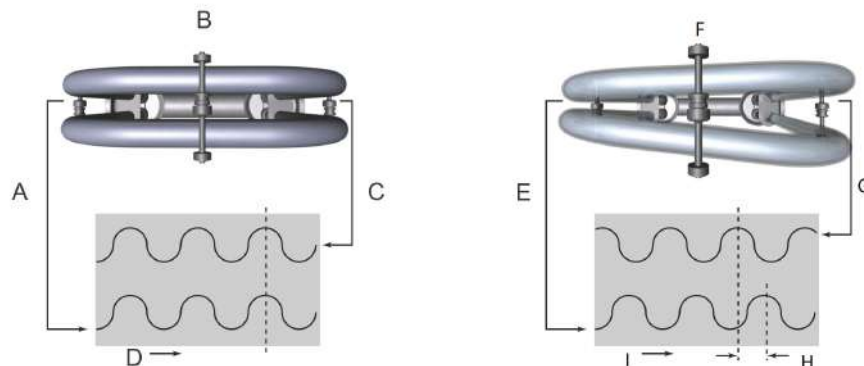

- A. Inlet pickoff displacement
- B. No flow
- C. Outlet pickoff displacement
- D. Time
- E. Inlet pickoff displacement
- F. With flow
- G. Outlet pickoff displacement
- H. Time difference
- I. Time

Density measurement

The measuring tubes are vibrated at their natural frequency. A change in the mass of the fluid contained inside the tubes causes a corresponding change to the tube natural frequency. The frequency change of the tube is used to calculate density.

Temperature measurement

Temperature is a measured variable that is available as an output. The temperature is also used internal to the sensor to compensate for temperature influences on Young's Modulus of Elasticity.

Meter characteristics

- Measurement accuracy is a function of fluid mass flow rate independent of operating temperature, pressure, or composition. However, pressure drop through the sensor is dependent upon operating temperature, pressure, and fluid composition.
- Specifications and capabilities vary by model and certain models may have fewer available options. For detailed information regarding performance and capabilities, either contact customer service or visit www.emerson.com/flowmeasurement.
- The letter at the end of the base model code (for example F100S) represents wetted part material and/or application designation: S = stainless steel, H = nickel alloy C22, P = high pressure, A = high temperature 316L stainless steel, B = high temperature nickel alloy C22. Detailed information about the complete product model codes are described later in this document.

Performance specifications

Reference operating conditions

Micro Motion calibrates:

- Water at 68 °F (20.0 °C) to 77 °F (25.0 °C) and 14.5 psig (1 barg) to 29 psig (2 barg)
- Accuracy based on industry leading accredited calibration standards according to ISO/IEC 17025
- A density range up to 3 g/cm³ (3,000 kg/m³)

Accuracy and repeatability

Accuracy and repeatability on liquids and slurries

Performance specifications	Premium ⁽¹⁾	Enhanced ⁽¹⁾	Intermediate	Basic
Mass and volume flow ⁽²⁾	±0.05%	±0.1%	±0.15%	±0.2%
Mass and volume repeatability	±0.025%	±0.05%	±0.075%	±0.10%
Density accuracy	±0.0005 g/cm ³ (±0.5 kg/m ³)	±0.001 g/cm ³ (±1 kg/m ³)		±0.002 g/cm ³ (±2 kg/m ³)
Density repeatability	±0.0002 g/cm ³ (±0.2 kg/m ³)	±0.0005 g/cm ³ (±0.5 kg/m ³)		±0.001 g/cm ³ (±1 kg/m ³)
Temperature accuracy	±1 °C ±0.5% of reading			
Temperature repeatability	±0.2 °C			

(1) Not available on all models.

(2) Stated flow accuracy includes the combined effects of repeatability, linearity, and hysteresis.

Accuracy and repeatability on gases

Performance specification	F050S/H, F100S/H, F200S/H, F300S/H, and F400S	F025S/H, all high temperature (A/B), and high pressure (P) models
Mass flow accuracy ⁽¹⁾	±0.35% of rate	±0.5% of rate
Mass flow repeatability ⁽¹⁾	0.25% of rate	±0.25% of rate
Temperature accuracy	±1 °C 0.5% of reading	
Temperature repeatability	±0.2 °C	

(1) Stated flow accuracy includes the combined effects of repeatability, linearity, and hysteresis.

Warranty

Warranty options on all F-Series models

The warranty period is generally initiated from the day of shipment. For warranty details, see the *Terms and Conditions* included with the standard product quote.

Base model	Included as standard	Included with startup service	Available for purchase
F025-400 (S/H/A/B/P)	18 months	36 months	> 36 months (customizable length)

Liquid flow rates

Nominal flow rate

Micro Motion has adopted the term nominal flow rate, which is the flow rate at which water at reference conditions causes approximately 14.5 psig (1 barg) of pressure drop across the meter.

Mass flow rates for all models

The following table shows mass flow rates using 316L stainless steel (S/A), nickel alloy C22 (H/B), and high pressure (P).

Model	Nominal line size	Nominal flow rate		Maximum flow rate	
		lb/min	kg/h	lb/min	kg/h
F025	0.25 in (DN6)	50	1,366	100	2,720
F050P	0.5 in (DN15)	84	2,287	168	4,570
F050S/H/A/B	0.5 in (DN15)	155	4,226	300	8,160
F100P	1 in (DN25)	400	11,000	800	22,000
F100S/H/A/B	1 in (DN25)	717	19,500	1,200	32,700
F200	2 in (DN50)	2,190	59,500	3,200	87,100
F300	3 in (DN80)	4,900	133,000	8,740	238,000
F400	4 in (DN100)	12,000	327,000	16,000	436,000

Volume flow rates for all models

The following table shows volume flow rates using 316L stainless steel (S/A), nickel alloy C22 (H/B), and high pressure (P).

Model	Nominal flow rate			Maximum flow rate		
	gal/min	barrels/h	l/h	gal/min	barrels/h	l/h
F025	6	9	1,370	12	18	2,720
F050S/H/A/B	19	27	4,230	38	52	8,160
F050P	10	15	2,290	20	29	4,570
F100P	48	69	11,000	96	138	22,000
F100S/H/A/B	86	123	19,500	144	206	32,700
F200	262	374	59,500	384	550	87,100
F300	587	839	133,000	1,050	1,500	238,000
F400	1,440	2,050	326,000	1,920	2,730	435,000

Gas flow rates

Gas flow rates

When selecting sensors for gas applications, pressure drop through the sensor is dependent upon operating temperature, pressure, and fluid composition. Therefore, when selecting a sensor for any particular gas application, it is highly recommended that each sensor be sized using the Online Store Sizing and Selection Tool at www.emerson.com/flowmeasurement.

Gas flow rates for all models

For general recommendations on nominal and maximum gas mass flow rates a Mach number of 0.2 or 0.3, respectively, use the gas being measured. The Sizing and Selection Tool will report both the actual velocity and the sonic velocity for each flow rate and meter size considered. The ratio of actual velocity divided by sonic velocity reflects the Mach number, or alternatively, the mass flow rate to match a particular Mach number can be calculated with the following formula:

$$\dot{m}_{(gas)} = \%M * \rho_{(gas)} * VOS * \frac{1}{4} \pi * D^2 * 2 \text{ (for sensors with dual-tube design)}$$

- $\dot{m}_{(gas)}$ Gas mass flow rate
- $\%M$ Use Mach number “0.2” for calculating typical nominal rate; use Mach number “0.3” for calculating maximum recommended rate. When Mach Numbers are above 0.3, most gas flows become compressible and significant increases in pressure drop may occur regardless of measurement device.
- $\rho_{(gas)}$ Gas density at operating conditions
- VOS Velocity of Sound of the measured gas
- D Internal diameter of the measuring tube

For a complete list of sensor tube IDs, see the *Micro Motion F-Series Flow and Density Meters Technical Data Sheet*.

Note

Gas maximum flow rate can never be greater than the liquid maximum rate; the lower of the two values should be assumed as applicable.

Sample calculation

The following calculation is an example of the maximum recommended gas mass flow rate for an F300S measuring natural gas with a molecular weight of 19.5 at 60 °F (16 °C) and 500 psig (34.47 barg):

$$\dot{m}_{(gas)} = 0.3 * 24(kg/m^3) * 430(m/s) * \frac{1}{4}\pi * .040m^2 * 2$$

$\dot{m}_{(gas)} = 28,012$ kg/hr; maximum recommended rate for F300S with natural gas at given conditions

- %M** 0.3 (used for calculating maximum recommended rate)
- Gas density** 24 kg/m³
- VOS_(NG)** 430 m/s (Velocity of Sound of natural gas at given conditions)
- F300S tube ID** 40 mm

Zero stability

Zero stability is used when the flow rate approaches the low end of the flow range where the meter accuracy begins to deviate from the stated accuracy rating, as depicted in the turndown section. When operating at flow rates where meter accuracy begins to deviate from the stated accuracy rating, accuracy is governed by the formula:
 Accuracy = +/-0.10% +/- (zero stability/flow rate) x 100%. Repeatability is similarly affected by low flow conditions.

Turndown capabilities

The graph and table below represent an example of the measurement characteristics under various flow conditions. At flow rates requiring large turndowns (greater than 20:1), the zero stability values may begin to govern capability dependent upon flow conditions and meter in use.

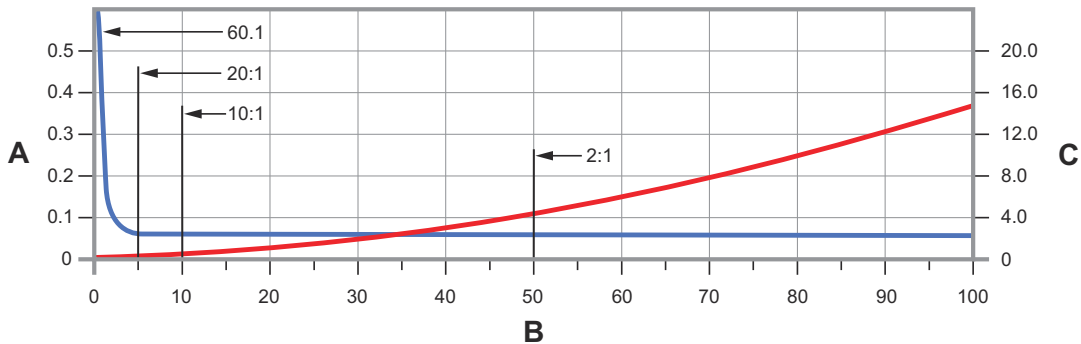

- A. Accuracy, % (blue line)
- B. Flow rate, % of nominal
- C. Pressure drop; psig, barg (red line)

Turndown from nominal flow rate	60:1	20:1	2:1	1:1
Accuracy	0.26	0.05	0.05	0.05
Pressure drop	0.0 psig (0.000 barg)	0.04 psig (0.0028 barg)	4.2 psig (0.290 barg)	14.5 psig (1.000 barg)

Zero stability for standard temperature/pressure models

The following table shows zero stability using 316L stainless steel (S) and nickel alloy C22 (H).

Model	Zero stability	
	lb/min	kg/h
F025S/H	0.001	0.03
F050S/H	0.005	0.136
F100S/H	0.017	0.463
F200S/H	0.065	1.769
F300S/H	0.33	9.0
F400S	0.50	13.64

Zero stability for high temperature (A/B) and high pressure models (P)

Model	Zero stability	
	lb/min	kg/h
F025A/B/P	0.005	0.136
F050A/B/P	0.006	0.163
F100A/B/P	0.05	1.361

Process pressure ratings

Sensor maximum working pressure reflects the highest possible pressure rating for a given sensor. Process connection type and environmental and process fluid temperatures may reduce the maximum rating. For common sensor and fitting combinations, refer to the *Micro Motion F-Series Flow and Density Meters Technical Data Sheet*.

All sensors comply with Council Directive 2014/68/EU on pressure equipment.

Note

F-Series sensors with JIS process connections do not comply with ASME® B31.1 power piping code.

Sensor maximum working pressure for all models

The following table shows maximum working pressure using 316L stainless steel (S/A), nickel alloy C22 (H/B), and high pressure (P).

Model ⁽¹⁾	Pressure
F025S/A, F050S/A, F100S/A, F200S, F300S, F400S	1,450 psig (100 barg)
F025H/B, F050H/B, F100H/B, F200H, F300H	2,160 psig (149 barg)
F025P	2,320 psig (160 barg)
F050P	5,800 psig (400 barg)
F100P	6,250 psig (431 barg)

(1) Higher pressure ratings may be available. Contact the factory for further information.

Case pressure

Case pressure for all models: 316L stainless steel (S/A), nickel alloy C22 (H/B), and high pressure (P)

Model	Case maximum pressure ⁽¹⁾	Typical burst pressure
F025	471 psig (32 barg)	1,884 psig (130 barg)
F050	383 psig (26 barg)	1,530 psig (105 barg)
F100	320 psig (22 barg)	1,281 psig (88 barg)
F200	190 psig (13 barg)	760 psig (52 barg)
F300	417 psig (29 barg)	1,668 psig (115 barg)
F400	241 psig (17 barg)	963 psig (66 barg)

(1) Case maximum pressure is determined by applying a safety factor of 4 to typical burst pressure.

Operating conditions: Environmental

Vibration limits

Meets IEC 60068-2-6, endurance sweep, 5 to 2000 Hz up to 1.0 g.

Temperature limits

Sensors can be used in the process and ambient temperature ranges shown in the temperature limit graphs. For the purposes of selecting electronics options, temperature limit graphs should be used only as a general guide. If your process conditions are close to the gray area, consult technical support.

Notes

- In all cases, the electronics cannot be operated where the ambient temperature is below -40 °F (-40.0 °C) or above 140 °F (60.0 °C). If a sensor is to be used where the ambient temperature is outside of the range permissible for the electronics, the electronics must be remotely located where the ambient temperature is within the permissible range, as indicated by the shaded areas of the temperature limit graphs.
- Temperature limits may be further restricted by hazardous area approvals. Refer to the hazardous area approvals documentation shipped with the sensor or at www.emerson.com/flowmeasurement.
- The extended-mount electronics option allows the sensor case to be insulated without covering the transmitter, core processor, or junction box, but does not affect temperature ratings. When insulating the sensor case at elevated process temperatures above 140 °F (60.0 °C), ensure electronics are not enclosed in insulation as this may lead to electronics failure.

Ambient and process temperature limits for standard-temperature models

The following chart shows ambient and process temperature limits for standard temperature models using 316L stainless steel (S), nickel alloy C22 (H), and high pressure (P).

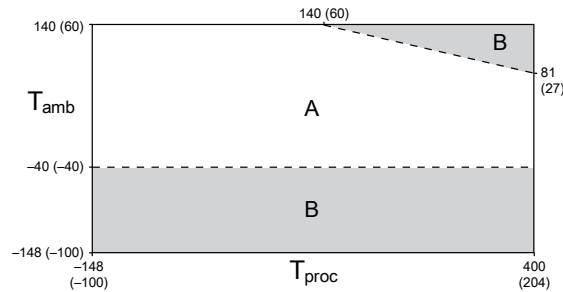

- T_{amb} = Ambient temperature °F (°C)
- T_{proc} = Process temperature °F (°C)
- A = All available electronic options
- B = Remote mount electronics only

Ambient and process temperature limits for high-temperature models

The following chart shows ambient and process temperature limits for high temperature models using 316L stainless steel (A) and nickel alloy C22 (B).

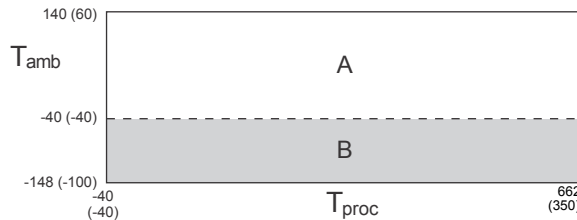

- T_{amb} = Ambient temperature °F (°C)
- T_{proc} = Process temperature °F (°C)
- A = All available electronic options
- B = Remote mount electronics only

Operating conditions: Process

Process pressure effect

Process pressure effect

Process pressure effect is defined as the change in sensor flow and density accuracy due to process pressure change away from the calibration pressure. This effect can be corrected by dynamic pressure input or a fixed meter factor. For proper setup and configuration, see the *Micro Motion F-Series Coriolis Flow and Density Sensors Installation Manual*.

Process pressure effect for all models

The following table shows the process pressure effect using 316L stainless steel (S/A), nickel alloy C22 (H/B), and high pressure (P).

Model	Mass flow (% of rate)		Density	
	per psi	per bar	g/cm ³ per psi	kg/m ³ per bar
F025	None	None	None	None
F050	-0.0008	-0.0116	None	None

Model	Mass flow (% of rate)		Density	
	per psi	per bar	g/cm ³ per psi	kg/m ³ per bar
F100	-0.0013	-0.01885	None	None
F200	-0.0007	-0.01015	-0.00003	-0.435
F300	-0.0012	-0.0174	-0.000017	-0.2465
F400	-0.0002	-0.0029	-0.000061	-0.884

Process temperature effect

- For mass flow measurement, process temperature effect is defined as the change in sensor flow accuracy due to process temperature change away from the calibration temperature. Temperature effect can be corrected by zeroing at the process conditions.
- For density measurement, process temperature effect is defined as the change in sensor density accuracy due to process temperature change away from the calibration density. See installation manual for proper setup and configuration.

The following table shows process temperature effect using 316L stainless steel (S/A), nickel alloy C22 (H/B), and high pressure (P).

Model code	Mass flow rate (% of maximum rate) per °C	Density per °C
F025	±0.0007	±0.0003 g/cm ³ (±0.3 kg/m ³)
F050, F100, F200, F300, F400	±0.0002	±0.0001 g/cm ³ (±0.1 kg/m ³)

Two-phase flow effect

NAMUR NE 132 guidelines state that, “Coriolis meters with a higher agitation frequency react more sensitively to gas bubbles in liquids when compared to devices with a lower agitation frequency.” For operating (agitation) frequency ranges for each model, see [Best practices: installing and selecting meters for two-phase flow](#).

Two-phase flow effects are governed by an increased decoupling ratio or a decreased Velocity of Sound (VoS) in the process fluid due to entrained gas, aeration, or the presence of liquid in gas. Following best practices regarding installation and meter selection can prevent or minimize measurement errors associated with two-phase flow effects.

Tip

For more details regarding the effects of two-phase flow on Coriolis meters, or performance expectations in these applications, see the *Entrained Gas Handling in Micro Motion Coriolis* white paper and any additional resources available at www.emerson.com/flowmeasurement.

Performance influences during two-phase flow conditions

Optimal meter performance during two-phase flow conditions is primarily governed by meter selection, flow regime, and fluid properties. Sample magnitudes of the effect are provided in the white paper referenced previously. The information in the following table provides common forms of influence quantities that can affect measurement performance during two-phase flow conditions.

Two-phase flow performance influence factors

Type of influence	Specific influence on measurement	Recommendation
VoS / fluid compressibility	Over-reading due to interaction between frequency of the acoustic and drive modes	Select a meter that operates in an ULTRA-LOW ⁽¹⁾ or LOW drive frequency range to avoid VoS effects.
Decoupling	Under-reading as a result of bubble or particle movement with respect to the fluid	Increase fluid viscosity, decrease bubble size, or use a meter with lower drive frequency in order to minimize decoupling.
Signal processing noise	Ability to maintain signal accuracy during high noise conditions or rapid process changes	Select advanced electronics that use high-speed mass and density signal processing methods for effective noise rejection.

(1) See [Operating drive mode frequency range for all models](#).

Best practices: installing and selecting meters for two-phase flow

Flow sensor best practices:

- Ensure that the meter is sized correctly to maintain a flow rate greater than 5:1 turndown from nominal.
- Install the meter with the preferred orientation. For orientation based on fluid type, see the *Micro Motion F-Series Coriolis Flow and Density Sensors Installation Manual*.
- Select a meter design with the lowest available operating frequency.

Transmitter and electronics best practices:

- Enable multiphase severity alerts to accurately detect when two-phase flow is present.
- Select a meter with a real-time clock and historian capabilities to diagnose process events or upsets.
- Use Advanced Phase Measurement in intermittent high %GVF or %LVF installations where density or volume flow is required.

Operating drive mode frequency range for all models

Reference conditions: water at 14.7 psig (1.014 barg) and 60 °F (16 °C).

- ULTRA-LOW (<100 hz)** Preferred solution for installations with two-phase flow conditions
- LOW (100 - 150 hz)** Preferred solution for installations with two-phase flow conditions
- MID-RANGE (150 - 300 hz)** Suitable in some instances for installations with two-phase flow conditions
- HIGH (> 300 hz)** Not recommended for two-phase flow installations

Range	Model code
ULTRA-LOW (< 100 Hz)	See the <i>Micro Motion F-Series Flow and Density Meters Product Data Sheet</i>
LOW (100-150 Hz)	See the <i>Micro Motion F-Series Flow and Density Meters Product Data Sheet</i>
MID-RANGE (150-300 Hz)	F025, F050, F100, F200, F300, F400
HIGH (> 300 Hz)	None

Viscosity range

For installations with 3 in (DN80) or larger meters, and fluid viscosities greater than 500 centistokes (cSt), consult your Micro Motion sales representative or technical support for guidance on optimizing your configuration. This recommendation is not applicable for smaller meters or processes with viscosities less than 500 cSt.

Pressure relief

F-Series sensors are available with a rupture disk installed on the case. Exceptions are high-temperature models (base model codes A and B) that are not available with rupture disks. Rupture disks vent process fluid from the sensor case in the unlikely event of a flow tube breach. Some users connect a pipeline to the rupture disk to help contain escaping process fluid. For more information about rupture disks, contact customer service.

If the sensor has a rupture disk, keep it installed at all times as it would otherwise be necessary to re-purge the case. If the rupture disk is activated by a tube breach, the seal in the rupture disk will be broken, and the Coriolis meter should be removed from service.



WARNING

- Orient the sensor so that personnel and equipment will not be exposed to any discharge along the pressure relief path.
- Stay clear of the rupture disk pressure relief area. High-pressure fluid escaping from the sensor can cause severe injury or death.

Important



If using a rupture disk, the housing can no longer assume a secondary containment function.

NOTICE

Removing the purge fitting, blind plug, or rupture disks compromises the Ex-i Safety Certification, the Ex-tc Safety Certification, and the IP-rating of the Coriolis meter. Any modification to the purge fitting, blind plug, or rupture disks must maintain a minimum of IP66/IP67 Ratings.

Hazardous area classifications

Approvals and certifications

Type	Approval or certification (typical)
CSA and CSA C-US	Ambient temperature: Ambient temperature: -40 °F (-40.0 °C) to 140 °F (60.0 °C) Class I, Div. 1, Groups C and D Class I, Div. 2, Groups A, B, C, and D Class II, Div. 1, Groups E, F, and G
ATEX	 II 2 G Ex ib IIB/IIC T6/T5/T4...T1 Ga/Gb II 2 D Ex ib IIIC T ⁽¹⁾ °C Db IP66/IP67
	 II 3G Ex nA IIC T5/T4...T1 Gc II 3D Ex tc IIIC T ⁽¹⁾ °C Dc IP66
IECEX	Ex ib IIB/IIC T6/T5/T4...T1 Ga/Gb Ex ib IIIC T ⁽¹⁾ °C Db IP66/67 Ex nA IIC T5/T4...T1 Gc Ex tc IIIC T ⁽¹⁾ °C Dc
NEPSI	Ex ib IIB/IIC T1-T4/T5/T6 Ga/Gb Ex nA IIC T1-T4/T5 Gc
Ingress Protection Rating	IP 66/67 for transmitters and sensors
EMC effects	Complies with EMC directive 2014/30/EU per EN 61326 Industrial
	Complies with NAMUR NE-21 edition: 2017-08-01

(1) For ambient and process temperature limits, refer to the appropriate approval certificate.

Notes

- Approvals shown are for F-Series meters. Meters with integral electronics may have more restrictive approvals. For transmitter details, see *Micro Motion F-Series Flow and Density Meters Technical Data Sheet*.
- When a meter is ordered with hazardous area approvals, detailed information is shipped along with the product.
- You can find more information about hazardous approvals, including detailed specifications and temperature graphs for all meter configurations on the F-Series product page at www.emerson.com/flowmeasurement.

Industry standards

Type	Standard
Weights & Measures for custody transfer applications	<ul style="list-style-type: none"> ■ MID OIML R117 ■ National Type Evaluation Program (NTEP) ■ Measurement Canada ■ INMETRO Brazil
Industry standards and commercial approvals	<ul style="list-style-type: none"> ■ NAMUR: NE132 (burst pressure, sensor flange to flange length), NE131 ■ Pressure Equipment Directive (PED) ■ Canadian Registration Number (CRN) ■ Dual Seal ■ ASME B31.1 power piping code and ASME B31.3 process piping code ■ SIL2 and SIL3 safety certifications

Note

Some models do not meet all of the listed standards. Contact a sales representative for more information.

Marine approval classifications

For models F025S, F050S, F100S/P, F200S and F300S.

Marine approval	Country
Lloyd’s Register ENV1, ENV2, ENV3, ENV5	United Kingdom
Det Norske Veritas- Germanischer Lloyd	Norway-Germany
Bureau Veritas	France
American Bureau of Shipping	USA
Nippon Kaiji Kyokai	Japan

Connectivity

F-Series sensors are highly customizable to provide a configuration that is tailor-fit to specific applications.

For help determining which Micro Motion products are right for your application, see the *Micro Motion Technical Overview and Specification Summary* and other resources at www.emerson.com/flowmeasurement.

Communication and diagnostic information

Transmitter interface

- Up to five fully configurable I/O channels, with options for 2-wire, Ethernet, and wireless communication
- Complete suite of mounting options to accommodate installation requirements — integral, remote, wall mount, and DIN rail
- Application software designed specific for your process — batching, concentration, and Advanced Phase Measurement



Diagnostic data

- Smart Meter Verification — checks the health and integrity of the meter's tubes, electronics, and calibration without interrupting the process
- Zero verification — quickly diagnoses the meter to determine if re-zeroing is recommended, and if process conditions are stable and optimal for zeroing
- Multiphase detection — proactively identifies multiphase process conditions and severity
- Time-stamped digital audit trails and reports for optimized agency compliance









Communication protocols

Typical I/O connectivity options include:

- 4-20 mA
- HART
- 10k Hz pulse
- Wireless
- Ethernet
- Modbus® TCP
- FOUNDATION fieldbus
- PROFINET
- PROFIBUS-PA
- PROFIBUS-DP
- Discrete I/O

Transmitter compatibility and primary attributes

For a complete list of all transmitter configurations and options, see the transmitter product data sheets and other resources available at www.emerson.com/flowmeasurement.

Model	Transmitter						
	1500/2500	1700/2700	2400S	3000 series	FMT	4200	5700
							
Flow meters							
F025, F050, F100	•	•	•	•	•	•	•
F200, F300, F400	•	•	•	•		•	•
Power							
AC		•	•	•			•
DC	•	•	•	•	•		•
Loop powered (2-wire)						•	
Diagnostics							
SMV basic (included)	•	•	•	•		•	•
SMV Pro	•	•	•	•		•	•
Real time clock						•	•
Onboard data historian						•	•
Local operator interface							
2-line display		•	•				
Graphical display				•		•	•
Certifications and approvals							
SIS certified		•				•	•
Custody transfer		•		•			•

Physical specifications

Materials of construction

General corrosion guidelines do not account for cyclical stress, and therefore should not be relied upon when choosing a wetted material for your Micro Motion meter.

For material compatibility information, see the *Micro Motion Corrosion Guide* at www.emerson.com.

Wetted path materials

Model	Material options			Sensor weight
	316L Stainless steel	Nickel alloy C22	Nickel alloy C22 and Stainless steel	
F025	F025S/A	F025H/B	F025P	10 lb (4.5 kg)
F050	F050S/A	F050H/B	F050P	11 lb (5.0 kg)
F100	F100S/A	F100H/B/P		21 lb (9.5 kg)
F200	F200S	F200H		42 lb (19 kg)
F300	F300S	F300H		105 lb (47.6 kg)
F400	F400S			180 lb (81.6 kg)

Notes

- Weight specifications are based upon ASME B16.5 CL150 flange and do not include electronics.
- Heat jackets and steam kits are also available.

Non-wetted part materials

Component	Enclosure rating	316L stainless steel	304L stainless steel	Polyurethane-painted aluminum
Sensor housing	NEMA 4X (IP66)		•	
Core processor housing	NEMA 4X (IP66/67)	•		•
Junction box housing	NEMA 4X (IP66/67)	•		•
1700/2700 transmitter housing	NEMA 4X (IP66/67/69K)	•		•
3700 transmitter housing	NEMA 4X (IP66/67)			•
2400S transmitter housing	NEMA 4X (IP66/67/69K) Stainless steel version	•		•
2200S transmitter housing	NEMA 4X (IP66/67)	•		•
4200 transmitter housing	NEMA 4X (IP66/67)			•
5700 transmitter housing	NEMA 4X (IP66/67/69K)	•		•

Flanges

Sensor type	Flange types
Stainless steel 316L	<ul style="list-style-type: none"> ■ ASME B16.5 weld neck flange raised face ■ EN 1092-1 weld neck flange form B1, B2, D, and F ■ JIS B2220 weld neck raised face ■ NAMUR NE 132 compliant flange options for standardized face-to-face dimensions ■ VCO, VCR swagelok compatible fitting ■ Hygienic Tri-Clamp® compatible
Nickel alloy C22	<ul style="list-style-type: none"> ■ ASME B16.5 lap joint flange ■ EN 1092-1 lap joint flange form B1 ■ JIS B2220 lap joint flange ■ Hygienic Tri-Clamp compatible
High pressure	<ul style="list-style-type: none"> ■ ASME B16.5 weld neck flange ■ VCO swagelok compatible fitting ■ EN 1092-1 weld neck flange type B2, D

Notes

- For flange compatibility, see the Online Store Sizing and Selection Tool at www.emerson.com/flowmeasurement.
- For more information on available NAMUR NE 132 compliant flange options, see the *Micro Motion F-Series Flow and Density Meters Technical Data Sheet*.

Dimensions

These dimensional drawings provide a basic guideline for sizing and planning.

For Face-to-Face (Dim. A, below) dimensions for all F-Series meters with each available process connection, see the *Micro Motion F-Series Flow and Density Meters Technical Data Sheet*.

For detailed dimensional drawings, go to www.emerson.com/flowmeasurement.

Notes

- All dimensions are ± 0.13 in (± 3 mm).
- Representative of a sensor model fitted with ASME B16.5 CL150 flange, and 2400 transmitter

Example dimensions for all models

Dimension drawings are applicable to 316L stainless steel (S/A), nickel alloy C22 (H/B), and high pressure (P).

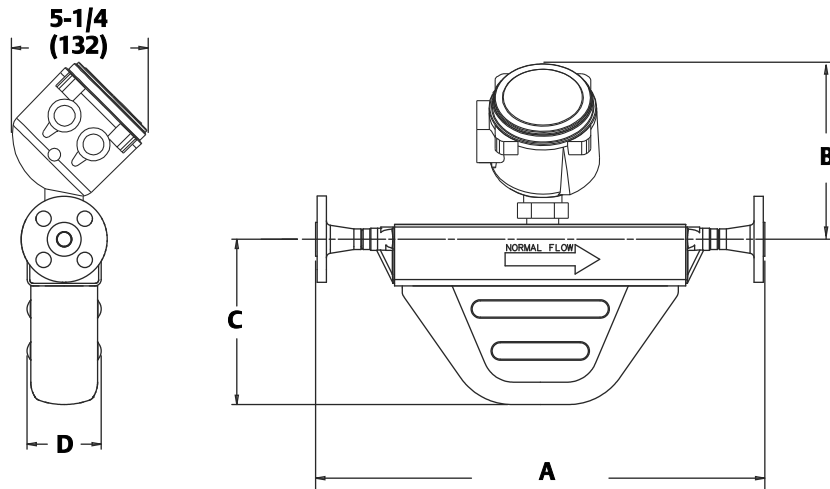

Model	Dim. A ASME B16.5 CL150	Dim. B	Dim. C	Dim. D
F025	16 in (406 mm)	6.97 in (177 mm)	5.12 in (130 mm)	2.80 in (71 mm)
F050	18.11 in (460 mm)	6.97 in (177 mm)	6.73 in (171 mm)	2.95 in (75 mm)
F100	22.68 in (576 mm)	7.17 in (182 mm)	9.13 in (232 mm)	4.13 in (105 mm)
F200	24.76 in (629 mm)	8.11 in (206 mm)	12.56 in (319 mm)	5.63 in (143 mm)
F300 ⁽¹⁾	34.6 in (879 mm)	9.84 in (250 mm)	11.14 in (283 mm)	7.32 in (186 mm)
F400	43.00 in (1,092 mm)	9.90 in (251.46 mm)	11.49 in (291.8 mm)	9.31 in (236 mm)

(1) Dimensions representative of model F300 with case code "E".

Ordering information

This section lists the available options and ordering codes for the F-Series product family.

Example model code

The sensor is shipped with a model code stamp so that after purchase, you can verify the ordering codes.



- A. Sensor and model
- B. Base model
- C. Process connection
- D. Case option
- E. Electronics interface
- F. Conduit connection
- G. Approval
- H. Language
- I. Additional standard approval
- J. Calibration
- K. Measurement application software
- L. Factory options
- M. Certificates, tests, calibrations, and services

Base model

Code descriptions

Codes B, A, P, H, and S are model designations used to identify the type of meter.

Model	Material
B	High temperature nickel alloy C22
A	High temperature 316L stainless steel
P	High pressure
H	Nickel alloy C22
S	316L stainless steel

Codes available by model

Model	Available codes				
	S	H	P	A	B
F025	S	H	P	A	B
F050	S	H	P	A	B
F100	S	H	P	A	B

Model	Available codes				
	S	H	P	A	B
F200	S	H			
F300	S	H			
F400	S				

Process connections

Model F025S

Code	Description					
113	0.5 in	CL150	ASME B16.5	F316/F316L	Weld neck flange	Raised face
114	0.5 in	CL300	ASME B16.5	F316/F316L	Weld neck flange	Raised face
115	0.5 in	CL600	ASME B16.5	F316/F316L	Weld neck flange	Raised face
116	DN15	PN40	DIN 2635	F316/F316L	Weld neck flange	Form C face
120	DN15	PN100/160	DIN 2638	F316/F316L	Weld neck flange	Form E face
121	0.5 in		Tri-Clamp compatible	316L	Hygienic fitting	
122	15 mm	20K	JIS B 2220	F316/316L	Weld neck flange	Raised face
150	0.5 in	CL900/1500	ASME B16.5	F316/316L	Weld neck flange	Raised face
170	DN15	PN100/160	EN 1092-1	F316/F316L	Weld neck flange	Type B2
172	DN25	PN40	EN 1092-1	F316/F316L	Weld neck flange	Type B1
176	DN15	PN40	EN 1092-1	F316/F316L	Weld neck flange	Type B1
178	DN15	PN100	EN 1092-1	F316/F316L	Weld neck flange	Type D
183	DN25	PN40	EN 1092-1	F316/F316L	Weld neck flange	Type D
221	15 mm	40K	JIS B 2220	F316/316L	Weld neck flange	Raised face
222	DN15		DIN11851	316/316L	Hygienic coupling	
310	DN15	PN40	EN 1092-1	F316/F316L	Weld neck flange	Type D
319	#8		VCO	316/316L	Swagelok compatible fitting	0.5 in (13 mm) NPT female adapter
A94	0.5 in	CL150	ASME B16.5	316/316L	Weld neck flange	Raised face 63-125 RA face finish
A95	0.5 in	CL300	ASME B16.5	316/316L	Weld neck flange	Raised face 63-125 RA face finish
A96	0.5 in	CL600	ASME B16.5	316/316L	Weld neck flange	Raised face 63-125 RA face finish
A97	0.5 in	CL900/1500	ASME B16.5	316/316L	Weld neck flange	Raised face 63-125 RA face finish
A99	0.75 in	CL150	ASME B16.5	316/316L	Weld neck flange	Raised face
B01	0.75 in	CL300	ASME B16.5	316/316L	Weld neck flange	Raised face

Code	Description					
B02	0.75 in	CL600	ASME B16.5	316/316L	Weld neck flange	Raised face
B03	0.75 in	CL900/1500	ASME B16.5	316/316L	Weld neck flange	Raised face
B04	1 in	CL150	ASME B16.5	316/316L	Weld neck flange	Raised face
B05	1 in	CL300	ASME B16.5	316/316L	Weld neck flange	Raised face
B06	1 in	CL600	ASME B16.5	316/316L	Weld neck flange	Raised face
B07	1 in	CL900/1500	ASME B16.5	316/316L	Weld neck flange	Raised face
B09	0.5 in	CL300	ASME B16.5	316/316L	Weld neck flange	RJT face
B10	0.5 in	CL600	ASME B16.5	316/316L	Weld neck flange	RJT face
B11	0.5 in	CL900/1500	ASME B16.5	316/316L	Weld neck flange	RJT face
B77	#8		VCR	316/316L	Swagelok compatible fitting	0.5 in (13 mm) NPT female adapter
B78	#12		VCR	316/316L	Swagelok compatible fitting	0.75 in (19 mm) NPT female adapter
C73	DN15	PN40	EN 1092-1	316/316L	Weld neck flange	Type F

Model F025A

Code	Description					
113	0.5 in	CL150	ASME B16.5	F316/F316L	Weld neck flange	Raised face
114	0.5 in	CL300	ASME B16.5	F316/F316L	Weld neck flange	Raised face
115	0.5 in	CL600	ASME B16.5	F316/F316L	Weld neck flange	Raised face
122	15 mm	20K	JIS B 2220	F316/F316L	Weld neck flange	Raised face
150	0.5 in	CL900/ 1500	ASME B16.5	F316/F316L	Weld neck flange	Raised face
170	DN15	PN100/160	EN 1092-1	F316/F316L	Weld neck flange	Type B2
172	DN25	PN40	EN 1092-1	F316/F316L	Weld neck flange	Type B1
176	DN15	PN40	EN 1092-1	F316/F316L	Weld neck flange	Type B1
178	DN15	PN100	EN 1092-1	F316/F316L	Weld neck flange	Type D
183	DN25	PN40	EN 1092-1	F316/F316L	Weld neck flange	Type D
221	15 mm	40K	JIS B 2220	F316/316L	Weld neck flange	Raised face
310	DN15	PN40	EN 1092-1	F316/F316L	Weld neck flange	Type D

Model F025P

Code	Description					
120	DN15	PN100/160	DIN 2638	F316/F316L	Weld neck flange	Form E face
150	0.5 in	CL900/ 1500	ASME B16.5	F316/F316L	Weld neck flange	Raised face
170	DN15	PN100/160	EN 1092-1	F316/F316L	Weld neck flange	Type B2
178	DN15	PN100	EN 1092-1	F316/F316L	Weld neck flange	Type D

Code	Description					
180	DN25	PN100	EN 1092-1	F316/F316L	Weld neck flange	Type B2
319	#8		VCO	316/316L	Swagelok compatible fitting	0.5 in (13 mm) NPT female adapter

Models F025H and F025B

Code	Description					
517	0.5 in	CL600	ASME B16.5	F304/F304L	Lap joint flange	N06022 stub
520	0.5 in	CL150	ASME B16.5	F304/F304L	Lap joint flange	N06022 stub
521	0.5 in	CL300	ASME B16.5	F304/F304L	Lap joint flange	N06022 stub
522	15 mm	10K	JIS B 2220	F304/F304L	Lap joint flange	N06022 stub
524	DN15	PN40	EN 1092-1	F304/F304L	Lap joint flange	Type B1, N06022 stub

Model F050S

Code	Description					
113	0.5 in	CL150	ASME B16.5	F316/F316L	Weld neck flange	Raised face
114	0.5 in	CL300	ASME B16.5	F316/F316L	Weld neck flange	Raised face
115	0.5 in	CL600	ASME B16.5	F316/F316L	Weld neck flange	Raised face
116	DN15	PN40	DIN 2635	F316/F316L	Weld neck flange	Form C face
120	DN15	PN100/160	DIN 2638	F316/F316L	Weld neck flange	Form E face
122	15 mm	20K	JIS B 2220	F316/316L	Weld neck flange	Raised face
131	DN25	PN40	DIN 2635	F316/F316L	Weld neck flange	Form C face
150	0.5 in	CL900/1500	ASME B16.5	F316/F316L	Weld neck flange	Raised face
170	DN15	PN100/160	EN 1092-1	F316/F316L	Weld neck flange	Type B2
172	DN25	PN40	EN 1092-1	F316/F316L	Weld neck flange	Type B1
176	DN15	PN40	EN 1092-1	F316/F316L	Weld neck flange	Type B1
178	DN15	PN100	EN 1092-1	F316/F316L	Weld neck flange	Type D
183	DN25	PN40	EN 1092-1	F316/F316L	Weld neck flange	Type D
221	15 mm	40K	JIS B 2220	F316/316L	Weld neck flange	Raised face
222	DN15		DIN11851	316/316L	Hygienic coupling	
239	#12		VCO	316/316L	Swagelok compatible fitting	0.75 in (19 mm) NPT female adapter
310	DN15	PN40	EN 1092-1	F316/F316L	Weld neck flange	Type D
322	0.75 in		Tri-Clamp compatible	316L	Hygienic fitting	
A94	0.5 in	CL150	ASME B16.5	316/316L	Weld neck flange	Raised face 63-125 RA face finish
A95	0.5 in	CL300	ASME B16.5	316/316L	Weld neck flange	Raised face 63-125 RA face finish

Code	Description					
A96	0.5 in	CL600	ASME B16.5	316/316L	Weld neck flange	Raised face 63-125 RA face finish
A97	0.5 in	CL900	ASME B16.5	316/316L	Weld neck flange	Raised face 63-125 RA face finish
A99	0.75 in	CL150	ASME B16.5	316/316L	Weld neck flange	Raised face
B01	0.75 in	CL300	ASME B16.5	316/316L	Weld neck flange	Raised face
B02	0.75 in	CL600	ASME B16.5	316/316L	Weld neck flange	Raised face
B03	0.75 in	CL900/1500	ASME B16.5	316/316L	Weld neck flange	Raised face
B04	1 in	CL150	ASME B16.5	316/316L	Weld neck flange	Raised face
B05	1 in	CL300	ASME B16.5	316/316L	Weld neck flange	Raised face
B06	1 in	CL600	ASME B16.5	316/316L	Weld neck flange	Raised face
B07	1 in	CL900/1500	ASME B16.5	316/316L	Weld neck flange	Raised face
B09	0.5 in	CL300	ASME B16.5	316/316L	Weld neck flange	RTJ face
B10	0.5 in	CL600	ASME B16.5	316/316L	Weld neck flange	RTJ face
B11	0.5 in	CL900/1500	ASME B16.5	316/316L	Weld neck flange	RTJ face
B77	#8		VCR	316/316L	Swagelok compatible fitting	0.5 in (13 mm) 316 NPT female adapter
B78	#12		VCR	316/316L	Swagelok compatible fitting	0.75 in (19 mm) 316 NPT female adapter
C73	DN15	PN40	EN 1092-1	316/316L	Weld neck flange	Type F

Model F050A

Code	Description					
113	0.5 in	CL150	ASME B16.5	F316/F316L	Weld neck flange	Raised face
114	0.5 in	CL300	ASME B16.5	F316/F316L	Weld neck flange	Raised face
115	0.5 in	CL600	ASME B16.5	F316/F316L	Weld neck flange	Raised face
122	15 mm	20K	JIS B 2220	F316/F316L	Weld neck flange	Raised face
150	0.5 in	CL900/ 1500	ASME B16.5	F316/F316L	Weld neck flange	Raised face
170	DN15	PN100/160	EN 1092-1	F316/F316L	Weld neck flange	Type B2
172	DN25	PN40	EN 1092-1	F316/F316L	Weld neck flange	Type B1
176	DN15	PN40	EN 1092-1	F316/F316L	Weld neck flange	Type B1
178	DN15	PN100	EN 1092-1	F316/F316L	Weld neck flange	Type D
183	DN25	PN40	EN 1092-1	F316/F316L	Weld neck flange	Type D
221	15 mm	40K	JIS B 2220	F316/316L	Weld neck flange	Raised face
310	DN15	PN40	EN 1092-1	F316/F316L	Weld neck flange	Type D

Model F050P

Code	Description					
113	0.5 in	CL150	ASME B16.5	F316/F316L	Weld neck flange	Raised face
114	0.5 in	CL300	ASME B16.5	F316/F316L	Weld neck flange	Raised face
115	0.5 in	CL600	ASME B16.5	F316/F316L	Weld neck flange	Raised face
116	DN15	PN40	DIN 2635	F316/F316L	Weld neck flange	Form C face
120	DN15	PN100/160	DIN 2638	F316/F316L	Weld neck flange	Form E face
122	15 mm	20K	JIS B 2220	F316/F316L	Weld neck flange	Raised face
131	DN25	PN40	DIN 2635	F316/F316L	Weld neck flange	Form C face
150	0.5 in	CL900/ 1500	ASME B16.5	F316/F316L	Weld neck flange	Raised face
170	DN15	PN100/160	EN 1092-1	F316/F316L	Weld neck flange	Type B2
178	DN15	PN100	EN 1092-1	F316/F316L	Weld neck flange	Type D
180	DN25	PN100	EN 1092-1	F316/F316L	Weld neck flange	Type B2
222	DN15		DIN11851	316/316L	Hygienic coupling	
239	#12		VCO	316/316L	Swagelok compatible fitting	0.75 in (19 mm) NPT female adapter
322	0.75 in		Tri-Clamp compatible	316L	Hygienic fitting	

Models F050H and F050B

Code	Description					
517	0.5 in	CL600	ASME B16.5	F304/F304L	Lap joint flange	N06022 stub
520	0.5 in	CL150	ASME B16.5	F304/F304L	Lap joint flange	N06022 stub
521	0.5 in	CL300	ASME B16.5	F304/F304L	Lap joint flange	N06022 stub
522	15 mm	10K	JIS B 2220	F304/F304L	Lap joint flange	N06022 stub
524	DN15	PN40	EN 1092-1	F304/F304L	Lap joint flange	Type B1, N06022 stub

Model F100S

Code	Description					
128	1 in	CL150	ASME B16.5	F316/F316L	Weld neck flange	Raised face
129	1 in	CL300	ASME B16.5	F316/F316L	Weld neck flange	Raised face
130	1 in	CL600	ASME B16.5	F316/F316L	Weld neck flange	Raised face
131	DN25	PN40	DIN 2635	F316/F316L	Weld neck flange	Form C face
137	DN25	PN100/160	DIN 2638	F316/F316L	Weld neck flange	Form E face
138	1 in		Tri-Clamp compatible	316L	Hygienic fitting	
139	25 mm	20K	JIS B 2220	F316/F316L	Weld neck flange	Raised face
179	DN25	PN40	EN 1092-1	F316/F316L	Weld neck flange	Type B1

Code	Description					
180	DN25	PN100	EN 1092-1	F316/F316L	Weld neck flange	Type B2
181	DN25	PN100	EN 1092-1	F316/F316L	Weld neck flange	Type D
209	2 in	CL150	ASME B16.5	F316/F316L	Weld neck flange	Raised face
229	25 mm	40K	JIS B 2220	F316/316L	Weld neck flange	Raised face
230	DN25		DIN11851	316/316L	Hygienic coupling	
311	DN25	PN40	EN 1092-1	F316/F316L	Weld neck flange	Type D
928	1 in	CL900/1500	ASME B16.5	F316/F316L	Weld neck flange	Raised face
B14	1 in	CL150	ASME B16.5	F316/F316L	Weld neck flange	Raised face 63-125 Ra face finish
B15	1 in	CL300	ASME B16.5	F316/F316L	Weld neck flange	Raised face 63-125 Ra face finish
B16	1 in	CL600	ASME B16.5	F316/F316L	Weld neck flange	Raised face 63-125 Ra face finish
B17	1.5 in	CL150	ASME B16.5	F316/F316L	Weld neck flange	Raised face
B18	1.5 in	CL300	ASME B16.5	F316/F316L	Weld neck flange	Raised face
B19	1.5 in	CL600	ASME B16.5	F316/F316L	Weld neck flange	Raised face
B20	1.5 in	CL900/1500	ASME B16.5	F316/F316L	Weld neck flange	Raised face
B21	2 in	CL300	ASME B16.5	F316/F316L	Weld neck flange	Raised face
B22	2 in	CL600	ASME B16.5	F316/F316L	Weld neck flange	Raised face
B23	2 in	CL900/1500	ASME B16.5	F316/F316L	Weld neck flange	Raised face
B24	1 in	CL300	ASME B16.5	F316/F316L	Weld neck flange	RTJ face
B25	1 in	CL600	ASME B16.5	F316/F316L	Weld neck flange	RTJ face
B26	1.5 in	CL900/1500	ASME B16.5	F316/F316L	Weld neck flange	RTJ face
B81	#16		VCO	F316/F316L	Swagelok compatible fitting	1 in (25 mm) 316 NPT female adapter
B82	#16		VCR	F316/F316L	Swagelok compatible fitting	1 in (25 mm) 316 NPT female adapter
C74	DN25	PN40	EN 1092-1	F316/F316L	Weld neck flange	Type F

Model F100A

Code	Description					
128	1 in	CL150	ASME B16.5	F316/F316L	Weld neck flange	Raised face
129	1 in	CL300	ASME B16.5	F316/F316L	Weld neck flange	Raised face
130	1 in	CL600	ASME B16.5	F316/F316L	Weld neck flange	Raised face
139	25 mm	20K	JIS B 2220	F316/F316L	Weld neck flange	Raised face
179	DN25	PN40	EN 1092-1	F316/F316L	Weld neck flange	Type B1
209	2 in	CL150	ASME B16.5	F316/F316L	Weld neck flange	Raised face
229	25 mm	40K	JIS B 2220	F316/316L	Weld neck flange	Raised face

Code	Description					
311	DN25	PN40	EN 1092-1	F316/F316L	Weld neck flange	Type D
928	1 in	CL900	ASME B16.5	F316/F316L	Weld neck flange	Raised face

Models F100H and F100B

Code	Description					
530	1 in	CL150	ASME B16.5	F304/F304L	Lap joint flange	N06022 stub
531	1 in	CL300	ASME B16.5	F304/F304L	Lap joint flange	N06022 stub
532	25 mm	10K	JIS B 2220	F304/F304L	Lap joint flange	N06022 stub
534	DN25	PN40	EN 1092-1	F304/F304L	Lap joint flange	Type B1, N06022 stub
535	1 in	CL600	ASME B16.5	F304/F304L	Lap joint flange	N06022 stub

Model F100P

Code	Description					
C55	1 in	CL2500	ASME B16.5	Nickel alloy C22	Weld neck flange	RTJ
C56	1.5 in	CL2500	ASME B16.5	Nickel alloy C22	Weld neck flange	RTJ
C57	1 in	CL2500 (360 bar)	ASME B16.5	F316/F316L	Weld neck flange	RTJ
C58	1.5 in	CL2500(360 bar)	ASME B16.5	F316/F316L	Weld neck flange	RTJ
C64	1 in	CL2500	ASME B16.5	F316/F316L	Weld neck flange	RTJ
C65	1.5 in	CL2500	ASME B16.5	F316/F316L	Weld neck flange	RTJ

Model F200S

Code	Description					
312	DN40	PN40	EN 1092-1	F316/F316L	Weld neck flange	Type D
316	DN50	PN40	EN 1092-1	F316/F316L	Weld neck flange	Type D
341	1.5 in inch	CL150	ASME B16.5	F316/F316L	Weld neck flange	Raised face
342	1.5 in	CL300	ASME B16.5	F316/F316L	Weld neck flange	Raised face
343	1.5 in	CL600	ASME B16.5	F316/F316L	Weld neck flange	Raised face
351	1.5 in		Tri-Clamp compatible	316L	Hygienic fitting	
352	2 in		Tri-Clamp compatible	316L	Hygienic fitting	
353	DN40		DIN11851	316/316L	Hygienic coupling	
363	DN40	PN100	EN 1092-1	F316/F316L	Weld neck flange	Type B2

Code	Description					
365	DN50	PN100	EN 1092-1	F316/F316L	Weld neck flange	Type B2
366	DN40	PN100	EN 1092-1	F316/F316L	Weld neck flange	Type D
367	DN50	PN100	EN 1092-1	F316/F316L	Weld neck flange	Type D
368	DN40	PN40	EN 1092-1	F316/F316L	Weld neck flange	Type B1
369	DN50	PN40	EN 1092-1	F316/F316L	Weld neck flange	Type B1
378	DN50	PN100	DIN 2637	F316/F316L	Weld neck flange	Form E face
381	DN40	PN40	DIN 2635	F316/F316L	Weld neck flange	Form C face
382	DN50	PN40	DIN 2635	F316/F316L	Weld neck flange	Form C face
385	40 mm	10K	JIS B 2220	F316/F316L	Weld neck flange	Raised face
386	50 mm	10K	JIS B 2220	F316/316L	Weld neck flange	Raised face
387	40 mm	20K	JIS B 2220	F316/F316L	Weld neck flange	Raised face
388	50 mm	20K	JIS B 2220	F316/316L	Weld neck flange	Raised face
418	2 in	CL150	ASME B16.5	F316/F316L	Weld neck flange	Raised face
419	2 in	CL300	ASME B16.5	F316/F316L	Weld neck flange	Raised face
420	2 in	CL600	ASME B16.5	F316/F316L	Weld neck flange	Raised face
A31	1.5 in	CL900/1500	ASME B16.5	F316/F316L	Weld neck flange	Raised face
A32	1.5 in	CL150	ASME B16.5	F316/F316L	Weld neck flange	Raised face 63-125 Ra face finish
A33	1.5 in	CL300	ASME B16.5	F316/F316L	Weld neck flange	Raised face 63-125 Ra face finish
A34	1.5 in	CL600	ASME B16.5	F316/F316L	Weld neck flange	Raised face 63-125 Ra face finish
A35	2 in	CL900/1500	ASME B16.5	F316/F316L	Weld neck flange	Raised face
A36	3 in	CL150	ASME B16.5	F316/F316L	Weld neck flange	Raised face
A37	3 in	CL300	ASME B16.5	F316/F316L	Weld neck flange	Raised face
A38	3 in	CL600	ASME B16.5	F316/F316L	Weld neck flange	Raised face
A39	2 in	CL150	ASME B16.5	F316/F316L	Weld neck flange	Raised face 63-125 Ra face finish
A40	2 in	CL300	ASME B16.5	F316/F316L	Weld neck flange	Raised face 63-125 Ra face finish
A41	2 in	CL600	ASME B16.5	F316/F316L	Weld neck flange	Raised face 63-125 Ra face finish
A42	2 in	CL150	ASME B16.5	F316/F316L	Weld neck flange	RTJ face
A43	2 in	CL300	ASME B16.5	F316/F316L	Weld neck flange	RTJ face
A44	2 in	CL600	ASME B16.5	F316/F316L	Weld neck flange	RTJ face
A45	2 in	CL900/1500	ASME B16.5	F316/F316L	Weld neck flange	RTJ face
B55	2 in	CL600	ASME B16.5	A105 Carbon Steel	Lap joint flange	316/316L stub

Code	Description					
B85	50 mm	10K	JIS B 2220	A105 Carbon Steel	Lap joint flange	316/316L stub
B86	50 mm	20K	JIS B 2220	A105 Carbon Steel	Lap joint flange	316/316L stub
C75	DN40	PN40	EN 1092-1	F316/F316L	Weld neck flange	Type F
C76	DN50	PN40	EN 1092-1	F316/F316L	Weld neck flange	Type F

Model F200H

Code	Description					
537	1.5 in inch	CL600	ASME B16.5	F304/F304L	Lap joint flange	N06022 stub
540	1.5 in	CL150	ASME B16.5	F304/F304L	Lap joint flange	N06022 stub
541	1.5 in	CL300	ASME B16.5	F304/F304L	Lap joint flange	N06022 stub
542	40 mm	10K	JIS 2220	F304/F304L	Lap joint flange	N06022 stub
544	2 in	CL150	ASME B16.5	F304/F304L	Lap joint flange	N06022 stub
545	2 in	CL300	ASME B16.5	F304/F304L	Lap joint flange	N06022 stub
546	50 mm	10K	JIS B 2220	F304/F304L	Lap joint flange	N06022 stub
548	DN40	PN40	EN 1092-1	F304/F304L	Lap joint flange	Type B1, N06022 stub
549	DN50	PN40	EN 1092-1	F304/F304L	Lap joint flange	Type B1, N06022 stub

Model F300S

Code	Description					
326	DN80	PN40	EN 1092-1	F316/F316L	Weld neck flange	Type D
333	DN100	PN40	EN 1092-1	F316/F316L	Weld neck flange	Type D
355	3 in	CL150	ASME B16.5	F316/F316L	Weld neck flange	Raised face
356	3 in	CL300	ASME B16.5	F316/F316L	Weld neck flange	Raised face
357	3 in	CL600	ASME B16.5	F316/F316L	Weld neck flange	Raised face
358	3 in	CL900	ASME B16.5	F316/F316L	Weld neck flange	Raised face
359	DN100	PN100	EN 1092-1	F316/F316L	Weld neck flange	Type D
361	3 in		Tri-Clamp compatible	316L	Hygienic fitting	
371	DN80	PN40	EN 1092-1	F316/F316L	Weld neck flange	Type B1
372	DN100	PN40	EN 1092-1	F316/F316L	Weld neck flange	Type B1
373	DN80	PN100	EN 1092-1	F316/F316L	Weld neck flange	Type B2
374	DN100	PN100	EN 1092-1	F316/F316L	Weld neck flange	Type B2
375	DN80	PN100	EN 1092-1	F316/F316L	Weld neck flange	Type D
391	DN80	PN40	DIN 2635	F316/F316L	Weld neck flange	Form C face

Code	Description					
392	DN100	PN40	DIN 2635	F316/F316L	Weld neck flange	Form C face
393	DN80	PN40	DIN 2635	F316/F316L	Weld neck flange	Form N grooved face
394	DN100	PN40	DIN 2635	F316/F316L	Weld neck flange	Form N grooved face
395	DN80	PN100	DIN 2637	F316/F316L	Weld neck flange	Form E face
396	DN100	PN100	DIN 2637	F316/F316L	Weld neck flange	Form E face
397	DN80	PN100	DIN 2637	F316/F316L	Weld neck flange	Form N grooved face
398	DN100	PN100	DIN 2637	F316/F316L	Weld neck flange	Form N grooved face
400	80 mm	10K	JIS B 2220	F316/F316L	Weld neck flange	Raised face
401	100 mm	10K	JIS B 2220	F316/F316L	Weld neck flange	Raised face
402	80 mm	20K	JIS B 2220	F316/F316L	Weld neck flange	Raised face
410	3 in		Grooved coupling	316L	Hygienic coupling	
425	4 in	CL150	ASME B16.5	F316/F316L	Weld neck flange	Raised face
426	4 in	CL300	ASME B16.5	F316/F316L	Weld neck flange	Raised face
427	4 in	CL600	ASME B16.5	F316/F316L	Weld neck flange	Raised face
428	4 in	CL900	ASME B16.5	F316/F316L	Weld neck flange	Raised face
A47	3 in	CL150	ASME B16.5	F316/F316L	Weld neck flange	Raised face 63-125 Ra face finish
A48	3 in	CL300	ASME B16.5	F316/F316L	Weld neck flange	Raised face 63-125 Ra face finish
A49	3 in	CL600	ASME B16.5	F316/F316L	Weld neck flange	Raised face 63-125 Ra face finish
A50	3 in	CL900	ASME B16.5	F316/F316L	Weld neck flange	Raised face 63-125 Ra face finish
A52	4 in	CL600	ASME B16.5	F316/F316L	Weld neck flange	Raised face 63-125 Ra face finish
A53	4 in	CL900	ASME B16.5	F316/F316L	Weld neck flange	Raised face 63-125 Ra face finish
A54	3 in	CL150	ASME B16.5	F316/F316L	Weld neck flange	RTJ face
A55	3 in	CL300	ASME B16.5	F316/F316L	Weld neck flange	RTJ face
A56	3 in	CL600	ASME B16.5	F316/F316L	Weld neck flange	RTJ face
A57	3 in	CL900	ASME B16.5	F316/F316L	Weld neck flange	RTJ face
A58	4 in	CL150	ASME B16.5	F316/F316L	Weld neck flange	RTJ face
A59	4 in	CL300	ASME B16.5	F316/F316L	Weld neck flange	RTJ face
A60	4 in	CL600	ASME B16.5	F316/F316L	Weld neck flange	RTJ face
A61	4 in	CL900	ASME B16.5	F316/F316L	Weld neck flange	RTJ face
B59	3 in	CL300	ASME B16.5	A105 Carbon Steel	Lap joint flange	316/316L stub

Code	Description					
B60	3 in	CL600	ASME B16.5	A105 Carbon Steel	Lap joint flange	316/316L stub
B87	100 mm	10K	JIS B 2220	A105 Carbon Steel	Lap joint flange	316/316L stub
B88	100 mm	20K	JIS B 2220	A105 Carbon Steel	Lap joint flange	316/316L stub
C77	DN80	PN40	EN 1092-1	F316/F316L	Weld neck flange	Type F
C78	DN100x80	PN40	EN 1092-1	F316/F316L	Weld neck flange	Type F

Model F300H

Code	Description					
539	3 in	CL600	ASME B16.5	F304/F304L	Lap joint flange	N06022 stub
550	3 in	CL150	ASME B16.5	F304/F304L	Lap joint flange	N06022 stub
551	3 in	CL300	ASME B16.5	F304/F304L	Lap joint flange	N06022 stub
552	80 mm	10K	JIS B 2220	F304/F304L	Lap joint flange	N06022 stub
554	DN80	PN40	EN 1092-1	F304/F304L	Lap joint flange	Type B1, N06022 stub
B76	3 in	CL600	Tri-Clamp compatible	Nickel alloy C22	Hygienic fitting	Type B

Model F400S

Code	Description					
435	4 in	CL150	ASME B16.5	F316/F316L	Weld neck flange	Raised face
436	4 in	CL300	ASME B16.5	F316/F316L	Weld neck flange	Raised face
437	4 in	CL600	ASME B16.5	F316/F316L	Weld neck flange	Raised face
443	DN100	PN40	EN 1092-1	F316/F316L	Weld neck flange	Type B1
445	DN100	PN40	EN 1092-1	F316/F316L	Weld neck flange	Type B2
447	DN100	PN100	EN 1092-1	F316/F316L	Hygienic fitting	Type D
470	100 mm	10K	JIS B 2220	F316/F316L	Weld neck flange	Raised face
472	100 mm	20K	JIS B 2220	F316/F316L	Weld neck flange	Raised face
480	DN100	PN40	EN 1092-1	F316/F316L	Weld neck flange	Type D
A63	4 in	CL150	ASME B16.5	F316/F316L	Weld neck flange	Raised face 63-125 Ra face finish
A64	4 in	CL300	ASME B16.5	F316/F316L	Weld neck flange	Raised face 63-125 Ra face finish
A65	4 in	CL600	ASME B16.5	F316/F316L	Weld neck flange	Raised face 63-125 Ra face finish
A72	4 in	CL150	ASME B16.5	F316/F316L	Weld neck flange	RTJ face
A73	4 in	CL300	ASME B16.5	F316/F316L	Weld neck flange	RTJ face

Code	Description					
A74	4 in	CL600	ASME B16.5	F316/F316L	Weld neck flange	RTJ face
B96	4 in	SCH 40	ASME B16.5	F316/F316L	Pipe stub	V groove
C78	DN100	PN40	EN 1092-1	F316/F316L	Weld neck flange	Type F
E49	4 in		Victaulic compatible	316L	Hygienic coupling	

Note

In the sections below, not all option codes are available with all models. See the F-Series product page (<https://www.emerson.com/en-us/catalog/micro-motion-f-coriolis>) or contact an Emerson sales representative to select the best options for your product configuration.

Case options

Code descriptions

Code	Code description
B	Compact case with secondary containment and test report
C	Compact case
D	Case with rupture disk 0.5 in NPT male
E	Enhanced case
F	3 in compact case retrofit installation (face-to-face extension mount)
P	Case with purge fittings 0.5 in NPT female

Electronics interface

Code descriptions

Code	Description
0	For integral mount 2400S transmitter
1	For extended mount 2400S transmitter
2	4-wire polyurethane-painted aluminum integral enhanced core processor for remote mount transmitters
3	4-wire stainless steel integral enhanced core processor for remote mount transmitters
4	4-wire polyurethane-painted aluminum integral extended mount enhanced core processor for remote mount transmitters
5	4-wire extended mount stainless steel integral enhanced core processor for remote mount transmitters
6	MVDSolo™; polyurethane-painted aluminum integral enhanced core processor (for OEMs) When electronics interface W, D, 6, 7, 8 or 9 is ordered with approval C, A, I, Z, P, or G (with Country Specific approval R1 or B1), MVD Direct Connect™ I.S. barrier is supplied.
7	MVDSolo; stainless steel integral enhanced core processor (for OEMs) When electronics interface W, D, 6, 7, 8 or 9 is ordered with approval C, A, I, Z, P, or G (with Country Specific approval R1 or B1), MVD Direct Connect I.S. barrier is supplied.

Code	Description
8	MVDSolo; extended mount polyurethane-painted aluminum integral enhanced core processor (for OEMs) When electronics interface W, D, 6, 7, 8 or 9 is ordered with approval C, A, I, Z, P, or G (with Country Specific approval R1 or B1), MVD Direct Connect I.S. barrier is supplied.
9	MVDSolo; extended mount stainless steel enhanced core processor (for OEMs) When electronics interface W, D, 6, 7, 8 or 9 is ordered with approval C, A, I, Z, P, or G (with Country Specific approval R1 or B1), MVD Direct Connect I.S. barrier is supplied.
C	For integrally mounted 1700 or 2700 transmitter
L	For integrally mounted standard-finish FMT transmitter Must be ordered with transmitter; only available with case code C; on F025S, only available with process connection 319, 121, or 222.
K	Integrally mounted improved-surface finish (64 Ra) FMT transmitter Must be ordered with transmitter; only available with case code C; on F025S, only available with process connection 319, 121, or 222.
R	9-wire polyurethane-painted aluminum junction box
H	9-wire polyurethane-painted aluminum junction box with extended mount
S	9-wire stainless steel junction box
T	9-wire stainless steel junction box with extended mount
J	For integrally mounted 2200S transmitter; only available with calibration option Z
U	Extended 2200S transmitter; only available with calibration option Z
F	For integral mount 5700 transmitter
Z	Other electronic interface (4200 transmitter) - requires a selection from Other electronics interface .

Conduit connections

Code descriptions

Code	Description
A	0.75 in (19 mm) NPT — no gland
B ⁽¹⁾	0.5 in (13 mm) NPT — no gland
E	M20 — no gland; not available with electronics interface code Q, A, V, or B in combination with approval code T or S on F200S-F300S
F ⁽¹⁾	Brass/nickel cable gland Cable diameter 0.335 in (8.5 mm) to 0.394 in (10.0 mm)
G ⁽¹⁾	Stainless steel cable gland Cable diameter 0.335 in (8.5 mm) to 0.394 in (10.0 mm)
H ⁽¹⁾	Brass/nickel cable gland
J ⁽¹⁾	Stainless steel cable gland
K ⁽²⁾	JIS B0202 1/2G - no gland
L ⁽²⁾	Japan - brass nickel gland
M ⁽²⁾	Japan - stainless cable gland

Code	Description
N ⁽²⁾	JIS B0202 3/4G - no gland
O ⁽²⁾	Japan - brass nickel gland
P ⁽²⁾	Japan - stainless cable gland

(1) Not available with approval code T, S, or J on F200-F300.

(2) Only available with approval code M, T, or S.

Approvals

Code descriptions

Read the approval code descriptions carefully to identify additional restrictions.

Code	Description
A	CSA (US and Canada): Class 1, Division 1, Groups C and D
C	CSA (Canada only); only available with material codes S and P (not available with material codes A, B, or H)
G	Country Specific Approval – Requires a selection from the Approvals section of the <i>Certificate, Tests, Calibrations and Services</i> model code option
I	IECEX Zone 1
M	Micro Motion Standard (no approval)
N	Micro Motion Standard / PED compliant
P	NEPSI; only available with language option M (Chinese)
S	TIIS – T3 Temperature Classification; not available for quote outside of Japan
T	TIIS - T4 Temperature Classification; not available for quote outside of Japan
U	UL; only available with models F025S-F200S
V	ATEX - Equipment Category 3 (Zone 2) / PED compliant
Z	ATEX - Equipment Category 2 (Zone 1) / PED compliant
2	CSA (US and Canada): Class 1, Division 2, Groups A,B,C,D
3	IECEX Zone 2

Languages

Code	Language option
A	Danish CE requirements document and English installation manual
D	Dutch CE requirements document and English installation manual
E	English installation manual
F	French installation manual
G	German installation manual
H	Finnish CE requirements document and English installation manual
I	Italian installation manual

Code	Language option
J	Japanese installation manual
M	Chinese installation manual
N	Norwegian CE requirements document and English installation manual
P	Portuguese installation manual
S	Spanish installation manual
W	Swedish CE requirements document and English installation manual
B	Hungarian CE requirements document and English installation manual
K	Slovak CE requirements document and English installation manual
T	Estonian CE requirements document and English installation manual
U	Greek CE requirements document and English installation manual
L	Latvian CE requirements document and English installation manual
V	Lithuanian CE requirements document and English installation manual
Y	Slovenian CE requirements document and English installation manual

Additional standard approvals

Code	Additional standard approvals
Z	No additional standard approval options selected; does not apply to F100P
Z	Rated to 5,220 psi (360 bar) – no additional standard approval options selected; only applies to F100P
N	Rated to 5,220 psi (360 bar) – all nickel alloy C22 components comply with NORSOK M-650 where applicable
H	Rated up to 6,250 psi (431 bar) – no additional standard approval options selected
K	Rated up to 6,250 psi (431 bar) – all nickel alloy C22 components comply with NORSOK M-650 where applicable

Calibration

Code	Calibration option
Z	±0.20% mass and 0.002 g/cm ³ (2 kg/m ³) density calibration
A	±0.15% mass and 0.002 g/cm ³ (2 kg/m ³) density calibration Not available on all models
1	±0.10% mass and 0.001 g/cm ³ (1 kg/m ³) density calibration Not available on all models
C	±0.10% mass and 0.002 g/cm ³ (2 kg/m ³) density calibration Not available on all models
K	±0.10% mass and 0.0005 g/cm ³ (0.5 kg/m ³) density calibration Not available on all models
2	±0.05% mass and 0.0005 g/cm ³ (0.5 kg/m ³) density calibration Not available on all models

Measurement application software (all models)

Code	Measurement application software option
Z	No measurement application software

Factory options

Code	Factory option
Z	Standard product
X	ETO product
R	Restocked product (if available)

Certificates, tests, calibrations, and services

These option codes can be added to the end of the model code if needed, but no code is required when none of these options is selected.

Note

There may be additional options or limitations depending on total meter configuration. Contact a sales representative before making your final selections.

Material quality examination tests and certificates

Select as many codes from this table as required.

Code	Factory option
MC	Material inspection certificate 3.1 (supplier lot traceability per EN 10204)
NC	NACE certificate 2.1 (MR0175 and MR0103)
KH	<p>KHK package 3.1 — certificate package to accommodate approval in Japan. Includes:</p> <ul style="list-style-type: none"> ■ Radiographic and tube wall examination ■ HSB witness primary containment hydrostatic and pneumatic testing ■ Material inspection certificate <p>Not available with codes RI, RC, HT, MC (because they are already included); not available with nickel alloy C22 models (F025H–F300H or F025B–F100B)</p>

Radiographic testing

Select only one code from the following table.

Code	Factory option
RE	X-ray package 3.1 (radiographic examination certificate; weld map; radiographic inspection NDE qualification)
RT	X-Ray package 3.1 (radiographic examination certificate with digital image; weld map; radiographic inspection NDE qualification)

Pressure testing

Code	Factory option
HT	Hydrostatic test certificate 3.1 (wetted components only)

Dye penetrant examination

Code	Factory option
D1	Dye penetrant test package 3.1 (Liquid Dye Penetration NDE Qualification): <ul style="list-style-type: none"> ■ Process connection only for F300 sensors ■ Sensor only for all other sensor models

Weld examination

Code	Factory option
WP	Weld procedure package (weld map, weld procedure specification, weld procedure qualification record, welder performance qualification)

Positive material testing

Select only one from this group.

Code	Factory option
PM	Positive material test certificate 3.1 (without carbon content)
PC	Positive material test certificate 3.1 (including carbon content); not available with nickel alloy C22 models (F025H–F300H or F025B–F100B)

ASME B31.1 power piping design code certification

Code	Factory option
GC	B31.1 power piping design code certification; not available with F100P

Special cleaning

Code	Factory option
O2	Declaration of compliance oxygen service 2.1

Accredited calibration

Code	Factory option
IC	ISO17025 accredited calibration and certificates (9 points total)

Special calibration options

Select either none, CV, or CV with one of the additional verification point options.

Note

Minimum flow rates may apply when selecting the special calibration option.

Code	Factory option
CV	Custom verification (alter original verification points)
01	Add 1 additional verification point
02	Add 2 additional verification point
03	Add 3 additional verification point
06	Add up to 6 additional verification points
08	Add up to 8 additional verification points
16	Add up to 16 additional verification points

Weights & Measures

Code	Factory option
WM	Tag for US NTEP certified applications; not available on F100P or any F025 or F300 models
WC	Tag for Measurements Canada certified applications; not available with approval code P

Sensor completion

Select as many codes from this table as required.

Code	Factory option
WG	Witness general
SP	Special packaging

Country specific approvals

Select one of the following if approval code G is selected. Not available on F100P.

Code	Factory option
R1	EAC Zone 1 – Hazardous Approval Not available with electronics code 0 or 1.
R3	EAC Zone 2 – Hazardous Approval Only available with electronics code 0,1, J, U, K, and L.
B1	INMETRO Zone 1 – Hazardous Approval Not available with electronics code 0 or 1.
B3	INMETRO Zone 2 – Hazardous Approval Only available with electronics code 0,1, J, U, K, and L.

Other electronics interface

Code	Factory option
UA	4200 integral mount aluminum housing

Emerson Automation Solutions

Worldwide Headquarters
7070 Winchester Circle
Boulder, Colorado USA 80301
T: +1 800-522-6277
T: +1 303-527-5200
F: +1 303-530-8459
Mexico: +52 55 5809 5300
Argentina: +54 11 4809 2700
Brazil: +55 15 3413 8000
Chile: +56 2 2928 4800
Peru: +51 15190130

Emerson Automation Solutions

Central Europe: +41 41 7686 111
Eastern Europe: +41 41 7686 111
Dubai: +971 4 811 8100
Abu Dhabi: +971 2 697 2000
Austria: +43 2236 607-0
France: +33 (0) 800 917 901
Germany: +49 (0) 2173 3348 0
Italy: +39 8008 77334
The Netherlands: +31 (0) 70 413 6666
Belgium: +32 2 716 77 11
Spain: 900 901 983
U.K. and Ireland: 0870 240 1978
Russian/CIS: +7 495 995 9559

Emerson Automation Solutions

Australia: (61) 3 9721 0200
China: (86) 21 2892 9000
India: (91) 22 6662 0566
Japan: +81-3-5769-6800
South Korea: (82) 31 8034 0000
Singapore: (65) 6 363 7766

©2020 Micro Motion, Inc. All rights reserved.

The Emerson logo is a trademark and service mark of Emerson Electric Co. Micro Motion, ELITE, ProLink, MVD and MVD Direct Connect marks are marks of one of the Emerson Automation Solutions family of companies. All other marks are property of their respective owners.