



Magnetic field sensor

50FY41-V4A-6

- Hall Effect Sensor
- Sensing range 2.5 mm
- 4-wire DC



Dimensions

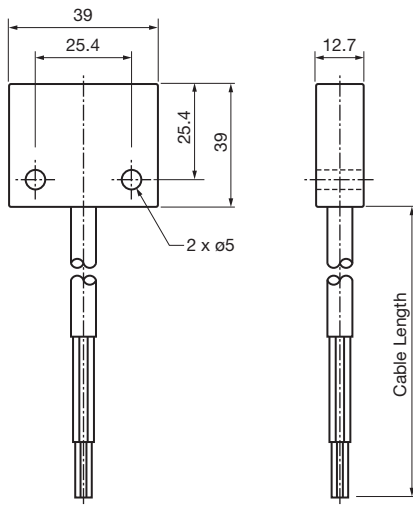

Technical Data

General specifications		
Switching function		Normally open (NO)
Output type		PNP/NPN
Rated operating distance	s_n	2.5 mm at 0 mm offset, 1.3 mm at 3.5 mm offset, 0 mm at 4.0 mm offset
Installation		non-flush
Output polarity		DC
Output type		4-wire
Nominal ratings		
Operating voltage	U_B	10 ... 12 V
Short-circuit protection		NO
Voltage drop	U_d	7 V @ 10 K load, 12 V supply
Operating current	I_L	0.5 mA
Current consumption		30 mA
Compliance with standards and directives		
Standard conformity		

Release date: 2022-06-30 Date of issue: 2022-06-30 Filename: 915922_eng.pdf

Refer to "General Notes Relating to Pepperl+Fuchs Product Information".

Pepperl+Fuchs Group
www.pepperl-fuchs.com

USA: +1 330 486 0001
fa-info@us.pepperl-fuchs.com

Germany: +49 621 776 1111
fa-info@de.pepperl-fuchs.com

Singapore: +65 6779 9091
fa-info@sg.pepperl-fuchs.com

PEPPERL+FUCHS

Technical Data

Standards	IEC 60947-5-2:2012 IEC 60947-5-3:2013 IEC 61236-3-1:2008
Approvals and certificates	
CE conformity	2014/30/EU
UL approval	cULus Listed, General Purpose
Ambient conditions	
Ambient temperature	-40 ... 100 °C (-40 ... 212 °F)
Mechanical specifications	
Connection type	cable PVC , 1.8 m
Core cross section	0.34 mm ²
Housing material	316 stainless steel
Sensing face	316 stainless steel
Degree of protection	IP69K
Note	Only approved for use with FYQLA1-140R-3 and KE5D2-6H/2R-S Use only with actuator 52FY31-V4A

Connection

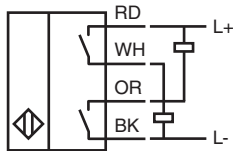

Accessories

	52FY31-V4A	Magnetic actuator
---	-------------------	-------------------