

Series P215PR/RM

Direct- and Remote-Mount Pressure-Actuated Condenser Fan Speed Controllers for Single-Phase Motors

Introduction

The Series P215PR/RM direct-mount and remote-mount pressure-actuated condenser fan speed controllers are designed for speed variation of single-phase motors. Head pressure control of a refrigeration system, through speed variation of the fan on an air-cooled condenser, results in optimum performance throughout the year. Once the output drops below 30%, the fan is cut off. The Series P215PR/RM controllers are designed for non-corrosive refrigerant systems. See Table 1 for a list of features and benefits.

A pressure-actuated control provides the most direct and fastest response to pressure variations in the refrigerant system. The controller varies the supply voltage to the motor from 30% to at least 95% over the proportional band using the phase-cutting principle. This principle provides speed variation of a permanent split capacitor or shaded pole motors that do not draw more than 4 A (RMS) full-load current. The motor manufacturer should have approved the product for this speed control principle.

We recommend confirming with the electric motor manufacturer that the motor can be used with a controller, using the phase-cutting principle for speed variation. You can also provide a copy of this product data sheet to the motor manufacturer or supplier for review.



Figure 1: P215PR Direct-Mount Pressure-Actuated Condenser Fan Speed Controller



Figure 2: P215RM Remote-Mount Pressure-Actuated Condenser Fan Speed Controller

Table 1: Features and Benefits

Feature	Benefit
Fan Speed Variation Condenser Pressure Control	Creates optimum condenser pressure control all year round and reduces noise during colder periods (such as nights).
Pressure Input	Allows direct and fast response to pressure variations.
Direct Mount Option	Allows for easy installation.
Remote Mount Option	Creates flexibility in mounting location.
Setpoint Screw Location on Top of Device	Allows for easy setpoint adjustment after installation.
Built-in Suppression Filter	Meets electro-magnetic compatibility requirements.
IP65 Enclosure	Allows for controller mounting outdoors.
Compact Design	Fits into small units and has a small turnaround circle.
Attractive Styling	Upgrades your equipment.
Quick Connector Plug Included	Allows for easy wiring and quick replacement.
Style 5 Remote Mount	Enables direct connection with flexible refrigeration hose.
Pressure Range 5-42 bar	Allows compatibility with all HFC types from R134a to R410a.

IMPORTANT: Use this Series P215PR/RM Pressure-Actuated Condenser Fan Speed Controller only as an operating control. Where failure or malfunction of the P215PR/RM could lead to personal injury or property damage to the controlled equipment or other property, additional precautions must be designed into the control system. Incorporate and maintain other devices, such as supervisory or alarm systems or safety or limit controls, intended to warn of or protect against failure or malfunction of the P215PR/RM Controller.

Installation

The controller must be mounted in an upright position on the refrigerant line, preferably at the condenser outlet side, to reduce pressure pulsation as much as possible.

Mount the controller within a 45° angle on both sides of the top of the high pressure line to avoid accumulation of oil inside the controller bellows and maintain the class IP65 rating. See Figure 3.

If you are using a pump-down system, the controller connection must be made at the high-pressure side of the system and upstream from the solenoid valve to avoid low pressure during pump-down.

The controller (IP65) can be mounted outdoors. See Figure 4. When mounted inside a cabinet, holes for air circulation must be provided.

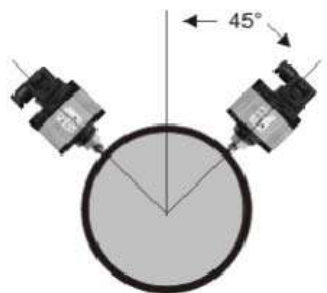

Figure 3: Mounting Position Range

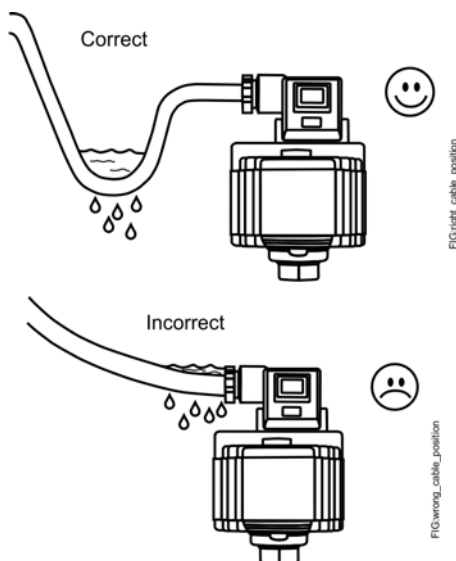

Figure 4: Cable Positioning

Wiring

The built-in EMC filter is designed for a maximum distance of 2 meters between the controller and the motor. Non-shielded cable must be used. The **gasket** must be placed between the quick connector plug and the controller terminals. The cable jacket must extend through the grommet. The **rubber O-ring** must be placed on the screw. Tighten screw securely. The screw fastens the connector plug to the controller terminals. The **gasket**, grommet, and **rubber O-ring** keep the IP65 protection class for the controller (see Figure 5).

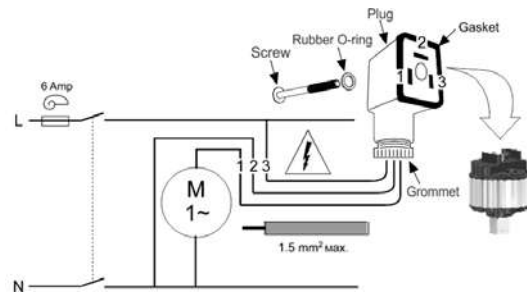

Figure 5: Wiring Details



WARNING: Risk of Electric Shock.

Disconnect or isolate all power supplies before making electrical connections. More than one disconnect or isolation may be required to completely de-energize equipment. Contact with components carrying hazardous voltage can cause electric shock and may result in severe personal injury or death.



CAUTION: Risk of Property Damage.

Do not apply power to the system before checking all wiring connections. Short circuited or improperly connected wires may result in permanent damage to the equipment.

Electro-Magnetic Capability

The controller includes a built-in suppression filter and meets required (EC) directives. However, when two or more Electro-Magnetic-Compatibility (EMC) compliant components are combined, the entire system may not be compliant. It is the end user's responsibility to make the entire system compliant.

Multiple motors can be wired in parallel, provided that the total current does not exceed the maximum limit.

Measuring

Use a True RMS meter for measuring amperes or volt values.

Adjustments

The setpoint is defined at 90% output value. The fixed cut-off value is 30% of the supplied voltage. Both the load and the supply voltage can affect the controller characteristic.

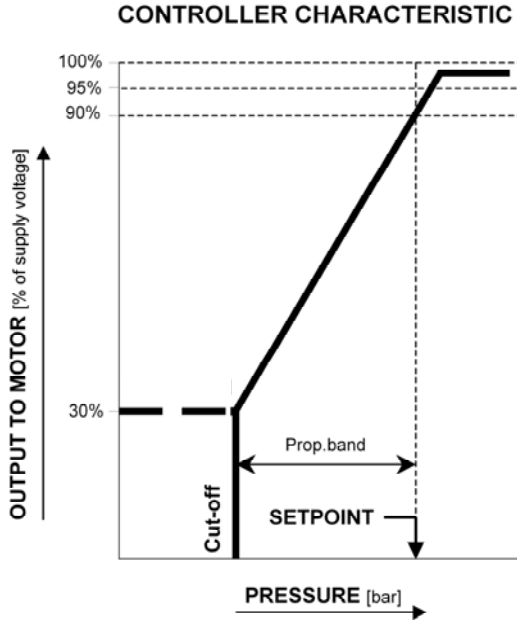

Figure 6: VDC Output Relative to Pressure Input

The proportional band is fixed and defined as the pressure difference between the points where the output values are 30% and 90% of the supply voltage. See Figure 6.

	Range (bar)		
	5 to 15	10 to 25	22 to 42
Proportional Band	3.0 ± 0.7	4.5 ± 1	5.5 ± 1.5

The values indicated are shown at 50 Hz power supply. At 60 Hz power supply, the cut-off and proportional band values decrease by 15%.

A built-in (fixed) hysteresis is included in the controller. This hysteresis is not indicated in the control characteristic, but is included in the proportional band.

Setpoint

The pressure setpoint at which your equipment operates can be adjusted by using the setpoint adjusting screw. See Figure 7.

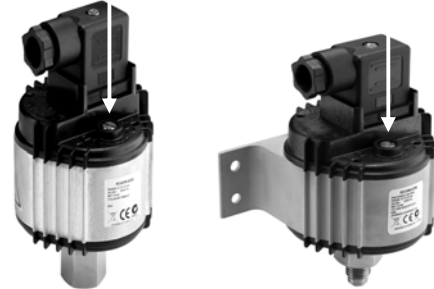

Figure 7: Setpoint Adjustment Screw

The setpoint is factory set at the values shown in the following table.

Control Range	Factory Setpoint
Range 5 to 15 bar	9 bar
Range 10 to 25 bar	19 bar
Range 22 to 42 bar	26 bar

Repair Information

If a Series P215PR/RM Condenser Fan Speed Controller fails to operate within its specifications, replace the unit. For a replacement Series P215PR/RM, contact the nearest Johnson Controls® representative. Provide the model number of the control when ordering a replacement. This number is found on the data plate. See Table 2 on page 4 for the Product Selection Chart.

Table 2: Product Selection Chart

Product Code Number	Range (bar)*	Element Style	Setting (bar)	Prop. Band (bar)	Minimum Shipping Quantity	Additional Features
P215PR-9200	10 to 25	47	19	4.5	1	
P215PR-9202	22 to 42	47	26	5.5	1	
P215PR-9203	5 to 15	47	9	3.0	1	
P215PR-9800	10 to 25	28	19	4.5	1	
P215PR-9230	10 to 25	47	19	4.5	25	Bulk Pack
P215PR-9232	22 to 42	47	26	5.5	25	Bulk Pack
P215PR-9233	5 to 15	47	9	3.0	25	Bulk Pack
P215PR-9250	10 to 25	47	19	4.5	15	Bulk Pack, 2 m cable connector included
P215RM-9700	10 to 25	5	19	4.5	1	
P215RM-9702	22 to 42	5	26	5.5	1	
P215RM-9703	5 to 15	5	9	3.0	1	

*1 bar = 100 kPa ≈ 14.5 psi

Pressure Connections and Dimensions

There are three types of pressure connections available. See Figure 8.

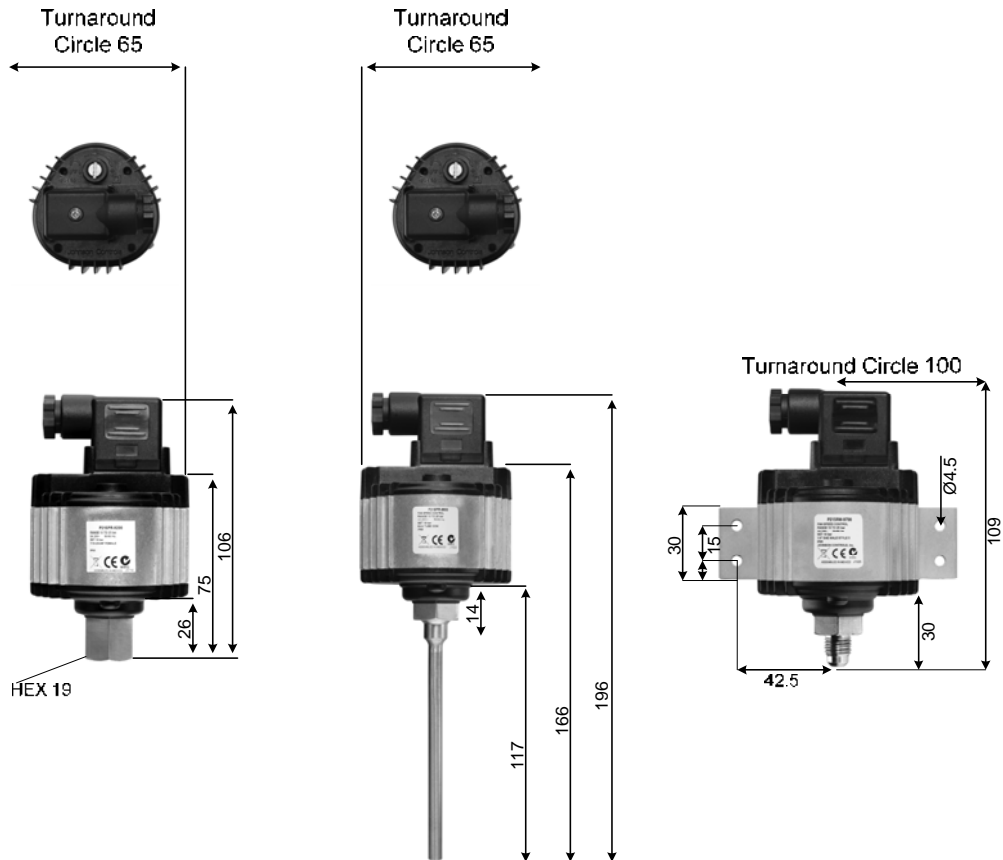



Figure 8: Pressure Connection Types: Style 47 (Left), Style 28 (Middle), Style 5 (Right), Dimensions, mm

Technical Specifications

P215PR/RM Pressure Actuated Controllers

Product	P215PR/RM Pressure-Actuated Condenser Fan Speed Controllers	
Pressure Range	5 to 15 bar 10 to 25 bar 22 to 42 bar	
Maximum Overrun Pressure	5 to 15 bar = 25 bar 10 to 25 bar = 40 bar 22 to 42 bar = 48 bar	
Pressure Connection	Style 5 (7/16-20 UNF male for 1/4 in. flared tubing connection) Style 47 (7/16-20 UNF female including valve depressor) Style 28 (with 100 mm tube, 6 mm ODM)	
Control Action	Direct	
Maximum Output Voltage	≥ 95% of Supply Voltage	
Maximum Current	4 A RMS (at maximum voltage output)	
Operating Ambient Temperature	-40° to 55°C	
Minimum Current	≥ 200 mA	
Residual Current Motor	≤ 25 mA	
Power Factor (cosφ) Motor	≥ 0.6	
Main Supply Voltage	230 VAC + 8% / -15%	
Main Supply Frequency	50/60 Hz	
Cut-off Point	30% of Supply Voltage	
Proportional Band (Range) at 50 Hz*	5 to 15 bar = 3.0 ± 0.7 bar 10 to 25 bar = 4.5 ± 1 bar 22 to 42 bar = 5.5 ± 1.5 bar	
	*Approximately 15% less at 60 Hz	
Storage Ambient Humidity	10 to 98% Relative Humidity (RH)	
Storage Ambient Temperature	-40 to 85°C	
Enclosure	IP65	
Material	Top/Bottom	Polycarbonate (glass filled)
	Heat Sink	Aluminium
	Pressure Connection	Brass
	Bellows	Phosphor Bronze
Shipping Weight	0.3 kg (Individual Pack)	
Wiring Connections	Screw Terminals 1-1/2 mm ² maximum Quick Connector Plug PG9 (6 to 7 mm cable)	
Compliance		CE Mark – Johnson Controls, Inc. declares that this product is in compliance with the essential requirements and other relevant provisions of the EMC Directive and Low Voltage Directive.
		RoHS Directive; WEEE Directive.

The performance specifications are nominal and conform to acceptable industry standards. For applications at conditions beyond these specifications, consult the local Johnson Controls office or representative. Johnson Controls shall not be liable for damages resulting from misapplication or misuse of its products.

United States Emissions Compliance

This equipment has been tested and found to comply with the limits for a Class B digital device, pursuant to Part 15 of the FCC Rules. These limits are designed to provide reasonable protection against harmful interference in a residential installation. This equipment generates, uses and can radiate radio frequency energy and, if not installed and used in accordance with the instructions, may cause harmful interference to radio communications. However, there is no guarantee that interference will not occur in a particular installation. If this equipment does cause harmful interference to radio or television reception, which can be determined by turning the equipment off and on, the user is encouraged to try to correct the interference by one or more of the following measures:

- Reorient or relocate the receiving antenna.
- Increase the separation between the equipment and receiver.
- Connect the equipment into an outlet on a circuit different from that to which the receiver is connected.
- Consult the dealer or an experienced radio/TV technician for help.

Canadian Emissions Compliance

This Class (B) digital apparatus meets all the requirements of the Canadian Interference-Causing Equipment Regulations. Cet appareil numérique de la Classe (B) respecte toutes les exigences du Règlement sur le matériel brouilleur du Canada.

European Single Point of Contact:

JOHNSON CONTROLS
WESTENDHOF 3
45143 ESSEN
GERMANY

NA/SA Single Point of Contact:

JOHNSON CONTROLS
507 E MICHIGAN ST
MILWAUKEE WI 53202
USA

APAC Single Point of Contact:

JOHNSON CONTROLS
C/O CONTROLS PRODUCT MANAGEMENT
NO. 22 BLOCK D NEW DISTRICT
WUXI JIANGSU PROVINCE 214142
CHINA



Johnson Controls International, Inc.

Headquarters:
European Headquarters:
European Factories:
Branch Offices:
This document is subject to change

Milwaukee, WI, USA
Westendhof 8, 45143 Essen, Germany
Lomagna (Italy), Leeuwarden (The Netherlands) and Essen (Germany)
Principal European Cities.
Printed in Europe