

**ebm-papst St. Georgen GmbH & Co. KG**

Hermann-Papst-Str. 1

D-78112 St. Georgen

Phone +49 (0) 7724 81-0

Fax +49 (0) 7724 81-1309

info2@de.ebmpapst.com

www.ebmpapst.com

**Nominal data**

Type	RER 120-26/14/2 TDMP	
Nominal voltage	VDC	24
Nominal voltage range	VDC	16 .. 32
Speed (rpm)	min <sup>-1</sup>	5200
Power consumption	W	51
Min. ambient temperature	°C	-20
Max. ambient temperature	°C	60
Air flow	m <sup>3</sup> /h	320
Sound power level	B	tbd

ml = Max. load · me = Max. efficiency · fa = Free air · cs = Customer specification · ce = Customer equipment  
Subject to change



**Technical description**

<b>General description</b>	3-phase fan drive with very smooth operation and high efficiency Backward-curved impeller
<b>Impeller material</b>	Glass-fiber reinforced plastic
<b>Weight</b>	0.43 kg
<b>Dimensions</b>	Ø 120 x 54 mm
<b>Airflow direction</b>	Axial: intake radial: discharge
<b>Direction of rotation</b>	Clockwise, viewed toward rotor
<b>Storage</b>	Ball bearing
<b>Service life L10 at 40 °C</b>	60000 h
<b>Service life L10 at maximum temperature</b>	37500 h
<b>Cable</b>	With leads AWG 18, 20 or AWG 22, TR 64. Speed signal and control input AWG 22

## Product drawing

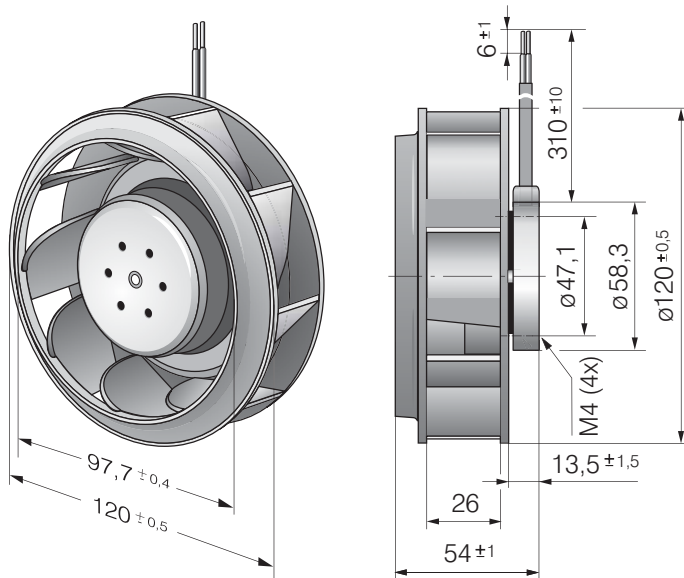

Curves

